

# Terminal Blocks, Fuse Blocks and Fuse Holders

Screw Connection



Spring Cage



Insulation Displacement Connection



## 42.1 IEC—XB Series

IEC—XB Series Overview	V7-T42-2
Screw Connection Terminal Blocks	V7-T42-4
Spring Cage Terminal Blocks	V7-T42-31
Pluggable Spring Cage Connection Terminal Blocks	V7-T42-58
IDC Terminal Blocks	V7-T42-67
Miniature Circuit Breakers	V7-T42-82
XB Series Accessories	V7-T42-90

## 42.2 NEMA

NEMA Overview	V7-T42-106
C381 Series Terminal Blocks, Rail Mounted	V7-T42-107
TB Series Terminal Blocks, Modular	V7-T42-111

## 42.3 Power Distribution

Power Distribution Overview	V7-T42-116
CHDB Series—Power Distribution Blocks	V7-T42-117
CH160 Series—Power Terminal Blocks	V7-T42-123
Power Terminal Block Accessories	V7-T42-126

## 42.4 Fuse Blocks and Fuse Holders

Fuse Blocks and Fuse Holders Overview	V7-T42-128
C383 Series Disconnect Fuse Holders	V7-T42-129
C350 Series Fuse Blocks and W Series Fuse Holders	V7-T42-131



Learn Online

IEC—XB Series

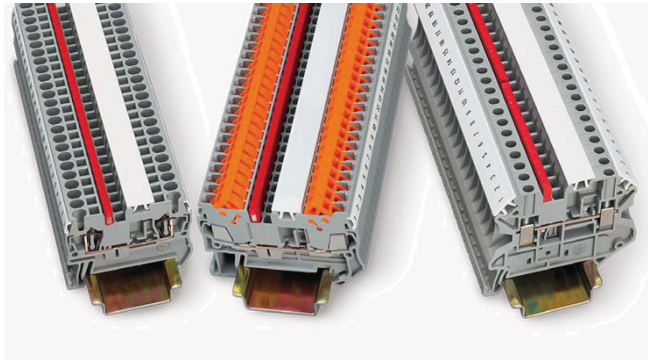

### IEC—XB Series Overview

#### Product Description

The **XB** Series from Eaton offers a complete terminal block system with a universal range of accessories. Marking, bridging and testing accessories are standardized across the different termination technologies—reducing inventory and logistics costs. The modular terminal block design allows for use of the different terminal block types together or individually, providing the highest degree of flexibility.

#### Application Description

The metal portion of the **XB** Series terminal blocks are made from high-grade, strain-crack and corrosion-proof copper alloys. They won't experience any electrolytic corrosion or rusting, even when moisture is present. The metal surfaces are protected with a lead-free, galvanic nickel or tin plating. The good electrical conductivity permits only a low temperature rise. The Polyamide 6.6 housings allow for operating temperatures up to 257°F (125°C) and are certified for inflammability Class V0 in accordance with UL 94.

#### Features

**Global acceptance**—The **XB** Series terminal blocks are designed to worldwide standards and meet the latest international requirements.

**Flexible Plug-in bridge system**—All three technologies (screw, spring and IDC) use the same bridge system, allowing for individual potential distribution and quickly bridged connections among the same terminal block type or across different types. The **XB** Series terminal blocks have two bridge shafts arranged in one line, making flexible chain bridging and skip bridging between non-adjacent terminal blocks possible. Plug-in bridges are available from 2 to 50 positions. Reducing bridges are also available to connect a larger terminal block to a smaller one.

### Contents

#### Description

Description	Page
IEC— <b>XB</b> Series	
Screw Connection Terminal Blocks . . . . .	<b>V7-T42-4</b>
Spring Cage Terminal Blocks . . . . .	<b>V7-T42-31</b>
Pluggable Spring Cage Connection Terminal Blocks . . . . .	<b>V7-T42-58</b>
IDC Terminal Blocks . . . . .	<b>V7-T42-67</b>
Miniature Circuit Breakers . . . . .	<b>V7-T42-82</b>
<b>XB</b> Series Accessories . . . . .	<b>V7-T42-90</b>

**Large surface area for marking**—All **XB** Series terminal blocks have generously sized surface areas for labeling. This allows for clearly labeled wiring that results in reduced startup time and simplifies activities such as testing and maintenance. There are provisions for marking individual terminal blocks and end stops, strips of terminal blocks, and large groups of terminal blocks.

**Standardized testing system**—All test plugs make contact in one of the easily accessible bridge shafts. A 2.3 mm diameter test plug is available for individual measuring wires. Modular test plugs are also available for more advanced testing.

#### Standards and Certifications

- UL® and cUL® recognized—File No. E67464
- CE approved
- LVD ①
  - EN 60947-7-1
  - EN 60947-7-2
  - EN 60998-2-3
  - EN 60352-4/A1
- ATEX approval (Ex e applications)



#### Note

① Not all standards apply to all terminal blocks. Contact Eaton for details.

## Technical Data and Specifications

### IEC—XB Series

Description	Specification
Insulation material	Polyamide 6.6
Dielectric strength	600 kV/cm
Creep resistance	600 CTI
Internal insulation resistance	10 <sup>12</sup> ohms cm
Surface resistance	10 <sup>10</sup> ohms
Flammability rating	UL 94 V0
Continuous operating temperature	–40 to 257°F (–40 to 125°C)

### Modular Terminal Blocks for Potentially Explosive Environments

The standard modular terminal blocks from Eaton are approved for potentially explosive environments. In addition to the usual approvals, they also have been approved by a testing center authorized by the EU. No extra approval is required in Intrinsic Safety type applications.

Modular terminal blocks on [www.eaton.com](http://www.eaton.com) fulfill the requirements for “Increased Safety” protection type when installation instructions are followed, and have a type examination certificate in accordance with the Ex directive Ex-RL 94/9/EU.

These test certificates are recognized in all the EU member states and beyond.

The modular terminal blocks are approved for fitting in Zone 1, the Ex environment, as well as Zone 2. Zone 1 fitting is conditional upon terminal blocks being used in connection boxes approved for EEx e type protection and having the equivalent of at least IP54 protection.

The EEx approved modular terminal blocks can be divided into the following groups:

- Screw connection terminal blocks
- Spring-cage connection terminal blocks
- Insulation Displacement Connection terminal blocks
- Mini terminal blocks
- Terminal blocks for specialized applications

**More detailed information on modular terminal blocks in the EEx e area is available on the Internet at [www.eaton.com](http://www.eaton.com) for downloading.**

Here you will find the following:

- Technical data in accordance with EN 50 019
- Approved accessories
- Important installation instructions and mounting diagrams
- EU type examination certificates
- General information on Ex protection

### Identifications

Explosion protected electrical equipment must be marked so that the safety characteristics are identifiable. The identification of electrical equipment is described in the harmonized standard EN 50014, as shown in the following example:

#### EN 50014 Standard Example

Description	Identification
Manufacturer or trademark	Eaton
Type designation	XBUT25
Abbreviation of explosion protection	EEx e II
Protection type increased safety “e”	e
Equipment group	II
Mark of the testing body	KEMA
Approval number	05ATEX2158 U

#### Identification in Accordance with ATEX-RL

Electrical equipment that is certified in accordance with the ATEX 100a guideline also receives identification describing the site for use.

#### ATEX Guideline Example

Description	Identification
Manufacturing data	02.01.2004
Address of the manufacturer	Duncan, SC
Number of the appointed dept.	344
Common marking	Ex symbol
Equipment group	II
Category	2
Use in gas and/or dust atmospheres	G D

Screw Connection



42

### Contents

<i>Description</i>	<i>Page</i>
Screw Connection Terminal Blocks	
Single Level—Through-Feed . . . . .	<b>V7-T42-5</b>
Single Level—Ground Blocks . . . . .	<b>V7-T42-10</b>
Multi-Conductor Terminal Blocks . . . . .	<b>V7-T42-12</b>
Multi-Conductor Ground Blocks . . . . .	<b>V7-T42-14</b>
Double Level . . . . .	<b>V7-T42-16</b>
Triple Level Sensor/Actuator . . . . .	<b>V7-T42-18</b>
Fuse Terminal Blocks . . . . .	<b>V7-T42-21</b>
Disconnect and Component Terminal Blocks . . . . .	<b>V7-T42-24</b>
High Current Blocks . . . . .	<b>V7-T42-27</b>
Mini Screw Connection . . . . .	<b>V7-T42-29</b>



Drawings  
Online

### Screw Connection Terminal Blocks Overview

#### Product Description

The XBUT Series uses a screw connection system that is accepted worldwide and is suitable in most applications. The maintenance-free connection provides the reliability you expect from Eaton.

#### Application Description

Designed for applications with high demands, the XBUT Series screw terminal block has a maintenance-free wire connection. re-tightening of the terminal screws is not necessary to ensure proper operation. The screw locking technique prevents the screws from backing out. Copper wires can be clamped without pre-treatment or ferrules can be used for splicing protection. Multiple conductors can be connected in the same clamping mechanism, saving space.

#### Features

- Maintenance-free connections
- Global acceptance
- Multi-conductor connections
- Flexible Plug-in bridge system
- Large surface area for marking
- Standardized testing system
- Metal parts made of tin-plated copper alloy

#### Standards and Certifications

- UL and cUL recognized—File No. E67464
- CE approved
- LVD ①:
  - EN 60947-7-1
  - EN 60947-7-2
  - EN 60998-2-3
  - EN 60352-4/A1
- ATEX approval (Eex e applications)



**Note**

① Not all standards apply to all terminal blocks. Contact Eaton for details.

Single Level—Through-Feed



## Single Level—Through-Feed

### Product Description

The XBUT terminal blocks feature a compact design and maintenance-free screw connection. There is a double bridge shaft providing maximum flexibility.

The double bridge shaft can accommodate individual chain bridging and step-down bridging from other terminal blocks. There are numerous options for accessories,

## Contents

### Description

	<i>Page</i>
Single Level—Through-Feed	
Product Selection . . . . .	<b>V7-T42-6</b>
Accessories . . . . .	<b>V7-T42-7</b>
Technical Data and Specifications . . . . .	<b>V7-T42-9</b>
Dimensions . . . . .	<b>V7-T42-9</b>
Single Level—Ground Blocks . . . . .	<b>V7-T42-10</b>
Multi-Conductor Terminal Blocks . . . . .	<b>V7-T42-12</b>
Multi-Conductor Ground Blocks . . . . .	<b>V7-T42-14</b>
Double Level. . . . .	<b>V7-T42-16</b>
Triple Level Sensor/Actuator . . . . .	<b>V7-T42-18</b>
Fuse Terminal Blocks . . . . .	<b>V7-T42-21</b>
Disconnect and Component Terminal Blocks . . . . .	<b>V7-T42-24</b>
High Current Blocks . . . . .	<b>V7-T42-27</b>
Mini Screw Connection . . . . .	<b>V7-T42-29</b>

including those for testing and marking. Terminal blocks are available for wire cross-sections ranging from 12 AWG (2.5 mm<sup>2</sup>) to 2/0 AWG (150 mm<sup>2</sup>).

# 42.1

## Terminal Blocks, Fuse Blocks and Fuse Holders

IEC—XB Series

### Product Selection

**XBUT4**



#### Screw Connection Single Level—Through-Feed

Terminal Width	Maximum Wire Size	IEC 60 947-7-1 in V/A/AWG	EN 50 019 <sup>①</sup> in V/A/AWG	UL-cUL Ratings in V/A/AWG	Color	Standard Pack	Catalog Number
5.2 mm	12 AWG/2.5 mm <sup>2</sup>	800/32/26–12	750/22/28/26–12	600/20/26–12	Gray	50	<b>XBUT25</b>
					Blue	50	<b>XBUT25BU</b>
6.2 mm	10 AWG/4 mm <sup>2</sup>	800/41/26–10	750/30/38/26–10	600/30/26–10	Gray	50	<b>XBUT4</b>
					Blue	50	<b>XBUT4BU</b>
					Orange	50	<b>XBUT4OR</b>
					Yellow	50	<b>XBUT4YE</b>
					Red	50	<b>XBUT4RD</b>
					White	50	<b>XBUT4WH</b>
					Black	50	<b>XBUT4BK</b>
8.2 mm	8 AWG/6 mm <sup>2</sup>	800/57/24–8	750/40/50/24–8	600/50/24–8	Gray	50	<b>XBUT6</b>
					Blue	50	<b>XBUT6BU</b>
10.2 mm	6 AWG/10 mm <sup>2</sup>	1000/76/20–6	750/54/69/20–6	600/65/20–6	Gray	50	<b>XBUT10</b>
					Blue	50	<b>XBUT10BU</b>
					Orange	50	<b>XBUT10OR</b>
					Yellow	50	<b>XBUT10YE</b>
					Red	50	<b>XBUT10RD</b>
12 mm	4 AWG/16 mm <sup>2</sup>	1000/101/17–4	—	600/85/16–4	Gray	50	<b>XBUT16</b>
					Blue	50	<b>XBUT16BU</b>
16 mm	0 AWG/35 mm <sup>2</sup>	1000/150/15–0	—	600/150/14–1/0	Gray	50	<b>XBUT35</b>
					Blue	50	<b>XBUT35BU</b>

**Note**

<sup>①</sup> EU type—examination certificate number: KEMA 05ATEX2158 U.

## Accessories

## Screw Connection Single Level—Through-Feed

Description	Color	Number of Positions	Standard Pack	XBUT25 Catalog Number	XBUT4 Catalog Number	XBUT6 Catalog Number	XBUT10 Catalog Number	XBUT16 Catalog Number	XBUT35 Catalog Number
End cover	Gray	—	10	<b>XBACUT10</b>	<b>XBACUT10</b>	<b>XBACUT10</b>	<b>XBACUT10</b>	<b>XBACUT16</b>	①
Partition plate	Gray	—	10	<b>XBATUT10</b>	<b>XBATUT10</b>	<b>XBATUT10</b>	<b>XBATUT10</b>	—	—
Plug-in bridge— for cross connections in the bridge shaft	Red	2	10	<b>XBAFBS25</b>	<b>XBAFBS26</b>	<b>XBAFBS28</b>	<b>XBAFBS210</b>	<b>XBAFBS212</b>	<b>XBAFBS216</b>
		3	10	<b>XBAFBS35</b>	<b>XBAFBS36</b>	—	—	—	—
		5	10	<b>XBAFBS55</b>	<b>XBAFBS56</b>	—	—	—	—
		10	10	<b>XBAFBS105</b>	<b>XBAFBS106</b>	—	—	—	—
		50	10	<b>XBAFBS505</b>	<b>XBAFBS506</b>	—	—	—	—
Test adapter	—	—	10	<b>XBATSPAI4</b>	<b>XBATSPAI4</b>	<b>XBATSPAI4</b>	—	—	—
2.3 mm diameter test plug	—	—	—	<b>XBATSMPS-</b> ①	<b>XBATSMPS-</b> ①	—	—	—	—
Modular test plug	—	—	10	<b>XBATSPS5</b>	<b>XBATSPS6</b>	<b>XBATSPS8</b>	—	—	—
Blank marker strip (strip of 10)	White	—	10	<b>XBMZB5</b> ②	<b>XBMZB6</b> ②	<b>XBMZB8</b> ②	<b>XBMZB10</b> ②	<b>XBMZB12</b> ②	<b>XBMZB15</b> ②

**Notes**① For ordering information, see **Page V7-T42-105**.② For information on Printed Marking Tag Options, see **Page V7-T42-98**.For additional accessories, see **Page V7-T42-90**.

# 42.1

## Terminal Blocks, Fuse Blocks and Fuse Holders

IEC—XB Series

### XBUT with Reducing Bridge

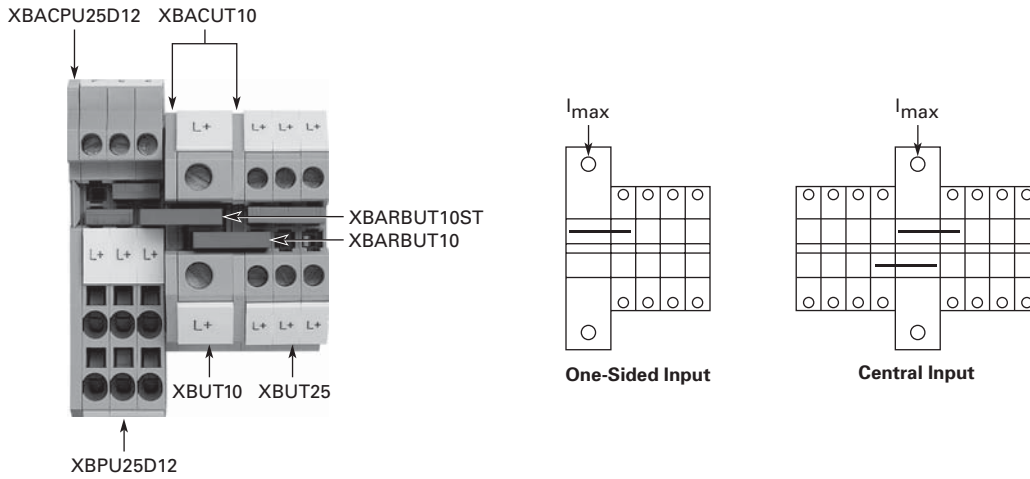

42

### Step-Down Bridge with Standard Feed-Through Terminal Blocks

Input Terminal Blocks	Cross-Section	Pick-Off Terminal Blocks	Cross-Section AWG (mm <sup>2</sup> )	One-Sided Input I <sub>max</sub>	Central Input I <sub>max</sub>	Bridge Catalog Number
XBUT10	6 AWG (10 mm <sup>2</sup> )	XBUT25	12 (2.5)	40	65	<b>XBARBUT10</b>
		XBUT4	10 (4)	45	65	<b>XBARBUT10</b>
		XBPT25	12 (2.5)	40	65	<b>XBARBUT10ST</b>
		XBPT4	10 (4)	45	65	<b>XBARBUT10ST</b>
		XBQT15	14 (1.5)	35	65	<b>XBARBUT10ST</b>
		XBQT25	12 (2.5)	40	65	<b>XBARBUT10ST</b>
XBUT16	4 AWG (16 mm <sup>2</sup> )	XBUT25	12 (2.5)	40	80	<b>XBARBUT16</b>
		XBUT4	10 (4)	45	90	<b>XBARBUT16</b>
		XBPT25	12 (2.5)	40	80	<b>XBARBUT16ST</b>
		XBPT4	10 (4)	45	90	<b>XBARBUT16ST</b>
		XBQT15	14 (1.5)	35	70	<b>XBARBUT16ST</b>
		XBQT25	12 (2.5)	40	80	<b>XBARBUT16ST</b>



## Technical Data and Specifications

### Screw Connection Single Level—Through-Feed

Description	XBUT25	XBUT4	XBUT6	XBUT10	XBUT16	XBUT35
<b>Technical Data in Accordance with IEC</b>						
Maximum load current in A/cross-section in mm <sup>2</sup>	32/4	41/6	57/10	76/16	101/25	150/50
Rated surge voltage in kV/contamination class	8/3	8/3	8/3	8/3	8/3	8/3
Surge voltage category/insulating material group	III/II	III/I	III/I	III/I	III/I	III/I
<b>Connection Capacity</b>						
Stranded with ferrule/with ferrule and plastic sleeve in mm <sup>2</sup>	0.25–2.5/0.25–2.5	0.25–4/0.25–4	0.25–6/0.25–6	0.5–10/0.5–10	1.0–16/1.0–16	1.5–35/1.5–35
<b>Multi-Conductor Connection</b> (same cross-section)						
Solid/stranded in mm <sup>2</sup>	0.14–1.5/0.14–1.5	0.14–1.5/0.14–1.5	0.2–2.5/0.2–2.5	0.5–4/0.5–4	1.0–6/1.0–4	1.5–16/1.5–10
Stranded with ferrules without plastic sleeve in mm <sup>2</sup>	0.25–1.5	0.25–1.5	0.25–1.5	0.5–2.5	1.0–4	1.5–10
Stranded with twin ferrule with plastic sleeve in mm <sup>2</sup>	0.5–1.5	0.5–2.5	0.5–4	0.5–6	0.75–10	1.5–10
Stripping length in inches (mm)	0.35 (9)	0.35 (9)	0.39 (10)	0.39 (10)	0.39 (10)	0.63 (16)
Thread	M3	M3	M4	M4	M5	M6
Torque in in-lb (Nm)	5.3–7.1 (0.6–0.8)	5.3–7.1 (0.6–0.8)	13.3–15.9 (1.5–1.8)	13.3–15.9 (1.5–1.8)	22.1–26.6 (2.5–3)	28.3–32.7 (3.2–3.7)

## Dimensions

Approximate Dimensions in Inches (mm)

### Screw Connection Single Level—Through-Feed

Catalog Number	Width	Length	Cover Width	Height for—	
				35 x 7.5 in	35 x 15 in
XBUT25	0.20 (5.2)	1.85 (46.9)	0.09 (2.2)	1.87 (47.5)	2.17 (55.0)
XBUT4	0.24 (6.2)	1.85 (46.9)	0.09 (2.2)	1.87 (47.5)	2.17 (55.0)
XBUT6	0.32 (8.2)	1.85 (46.9)	0.09 (2.2)	1.87 (47.5)	2.17 (55.0)
XBUT10	0.40 (10.2)	1.85 (46.9)	0.09 (2.2)	1.87 (47.5)	2.17 (55.0)
XBUT16	0.47 (12.0)	2.08 (52.8)	0.09 (2.2)	2.16 (54.8)	2.45 (62.3)
XBUT35	0.63 (16.0)	2.37 (60.2)	—	2.59 (65.7)	2.88 (73.2)

#### Notes

- ① XBUT35 has an enclosed design. The use of an end cover is not required.
- ② For information on Printed Marking Tag Options, see **Page V7-T42-98**.

# 42.1

## Terminal Blocks, Fuse Blocks and Fuse Holders

IEC—XB Series

### Single Level—Ground Blocks



### Contents

#### Description

<i>Description</i>	<i>Page</i>
Single Level—Through-Feed .....	<b>V7-T42-5</b>
Single Level—Ground Blocks	
Accessories .....	<b>V7-T42-11</b>
Technical Data and Specifications .....	<b>V7-T42-11</b>
Dimensions .....	<b>V7-T42-11</b>
Multi-Conductor Terminal Blocks .....	<b>V7-T42-12</b>
Multi-Conductor Ground Blocks .....	<b>V7-T42-14</b>
Double Level .....	<b>V7-T42-16</b>
Triple Level Sensor/Actuator .....	<b>V7-T42-18</b>
Fuse Terminal Blocks .....	<b>V7-T42-21</b>
Disconnect and Component Terminal Blocks .....	<b>V7-T42-24</b>
High Current Blocks .....	<b>V7-T42-27</b>
Mini Screw Connection .....	<b>V7-T42-29</b>

42

### Single Level—Ground Blocks

#### Product Description

The ground terminal blocks have the same shape and pitch as the standard terminal block, in a green-yellow housing. They easily snap

onto the DIN rail to make a reliable mechanical and electrical contact that meets all requirements of IEC 60-947-7-2.

#### Product Selection

**XBUT6PE**



#### Screw Connection Single Level—Ground Blocks

Terminal Width	Maximum Wire Size	IEC 60 947-7-1 in V/A/AWG	EN 50 019 ① in V/A/AWG	UL-cUL Ratings in V/A/AWG	Color	Standard Pack	Catalog Number
5.2 mm	12 AWG/2.5 mm <sup>2</sup>	—/—/26-12	—/—/26-12	—/—/26-12	Green/Yellow	50	<b>XBUT25PE</b>
6.2 mm	10 AWG/4 mm <sup>2</sup>	—/—/26-10	—/—/26-10	—/—/26-10	Green/Yellow	50	<b>XBUT4PE</b>
8.2 mm	8 AWG/6 mm <sup>2</sup>	—/—/24-8	—/—/24-8	—/—/24-8	Green/Yellow	50	<b>XBUT6PE</b>
10.2 mm	6 AWG/10 mm <sup>2</sup>	—/76/20-6	—/54/69/20-6	—/—/20-6	Green/Yellow	50	<b>XBUT10PE</b>
12 mm	4 AWG/16 mm <sup>2</sup>	—/101/15-4	—	—/—/16-4	Green/Yellow	50	<b>XBUT16PE</b>
16 mm	2 AWG/35 mm <sup>2</sup>	—/125/15-2	—	—/—/14-1/0	Green/Yellow	50	<b>XBUT35PE</b>

#### Note

① EU type—examination certificate number: KEMA 05ATEX2158 U.

## Accessories

### Screw Connection Single Level—Ground Blocks

Description	Color	Number of Positions	Standard Pack	XBUT25PE Catalog Number	XBUT4PE Catalog Number	XBUT6PE Catalog Number	XBUT10PE Catalog Number	XBUT16PE Catalog Number	XBUT35PE Catalog Number
End cover	Gray	—	10	<b>XBACUT10</b>	<b>XBACUT10</b>	<b>XBACUT10</b>	<b>XBACUT10</b>	<b>XBACUT16</b>	③
Partition plate	—	—	10	<b>XBATUT10</b>	<b>XBATUT10</b>	<b>XBATUT10</b>	<b>XBATUT10</b>	—	—
Plug-in bridge— for cross connections in the bridge shaft	Red	2	10	<b>XBAFBS25</b>	<b>XBAFBS26</b>	<b>XBAFBS28</b>	<b>XBAFBS210</b>	<b>XBAFBS212</b>	<b>XBAFBS212</b>
		3	10	<b>XBAFBS35</b>	<b>XBAFBS36</b>	—	—	—	—
		5	10	<b>XBAFBS55</b>	<b>XBAFBS56</b>	—	—	—	—
		10	10	<b>XBAFBS105</b>	<b>XBAFBS106</b>	—	—	—	—
		50	10	<b>XBAFBS505</b>	<b>XBAFBS506</b>	—	—	—	—
Test adapter	—	—	10	<b>XBATSPAI4</b>	<b>XBATSPAI4</b>	<b>XBATSPAI4</b>	—	—	—
2.3 mm diameter test plug	—	—	—	<b>XBATSMPS_</b> ①	<b>XBATSMPS_</b> ①	—	—	—	—
Modular test plug	—	—	10	<b>XBATSPS5</b>	<b>XBATSPS6</b>	<b>XBATSPS8</b>	—	—	—
Blank marker strip (strip of 10)	White	—	10	<b>XBMZB5</b> ②	<b>XBMZB6</b> ②	<b>XBMZB8</b> ②	<b>XBMZB10</b> ②	<b>XBMZB12</b> ②	<b>XBMZB15</b> ②

## Technical Data and Specifications

### Screw Connection Single Level—Ground Blocks

Description	XBUT25PE	XBUT4PE	XBUT6PE	XBUT10PE	XBUT16PE	XBUT35PE
<b>Technical Data in Accordance with IEC</b>						
Maximum load current in A/cross-section in mm <sup>2</sup>	—	—	—	76/16	101/25	125/50
Rated surge voltage in kV/contamination class	8/3	8/3	8/3	8/3	8/3	8/3
Surge voltage category/insulating material group	III/II	III/I	III/I	III/I	III/I	III/I
<b>Connection Capacity</b>						
Stranded with ferrule/with ferrule and plastic sleeve in mm <sup>2</sup>	0.25–2.5/0.25–2.5	0.25–4/0.25–4	0.25–6/0.25–6	0.5–10/0.5–10	1.0–16/1.0–16	1.5–35/1.5–35
<b>Multi-Conductor Connection</b> (same cross-section)						
Solid/stranded in mm <sup>2</sup>	0.14–1.5/0.14–1.5	0.14–1.5/0.14–1.5	0.2–2.5/0.2–2.5	0.5–4/0.5–4	1.0–6/1.0–4	1.5–16/1.5–10
Stranded with ferrules without plastic sleeve in mm <sup>2</sup>	0.25–1.5	0.25–1.5	0.25–1.5	0.5–2.5	1.0–4	1.5–10
Stranded with twin ferrule with plastic sleeve in mm <sup>2</sup>	0.5–1.5	0.5–2.5	0.5–4	0.5–6	0.75–10	1.5–10
Stripping length in inches (mm)	0.35 (9)	0.35 (9)	0.39 (10)	0.39 (10)	0.39 (10)	0.63 (16)
Thread	M3	M3	M4	M4	M5	M6
Torque in in-lb (Nm)	5.3–7.1 (0.6–0.8)	5.3–7.1 (0.6–0.8)	13.3–15.9 (1.5–1.8)	13.3–15.9 (1.5–1.8)	22.1–26.6 (2.5–3)	28.3–32.7 (3.2–3.7)

## Dimensions

Approximate Dimensions in Inches (mm)

### Screw Connection Single Level—Ground Blocks

Catalog Number	Width	Length	Cover Width	Height for—	
				35 x 7.5 in	35 x 15 in
<b>XBUT25PE</b>	0.20 (5.2)	1.85 (46.9)	0.09 (2.2)	1.87 (47.5)	2.17 (55.0)
<b>XBUT4PE</b>	0.24 (6.2)	1.85 (46.9)	0.09 (2.2)	1.87 (47.5)	2.17 (55.0)
<b>XBUT6PE</b>	0.32 (8.2)	1.85 (46.9)	0.09 (2.2)	1.87 (47.5)	2.17 (55.0)
<b>XBUT10PE</b>	0.40 (10.2)	1.85 (46.9)	0.09 (2.2)	1.87 (47.5)	2.17 (55.0)
<b>XBUT16PE</b>	0.47 (12.0)	2.08 (52.8)	0.09 (2.2)	2.16 (54.8)	2.45 (62.3)
<b>XBUT35PE</b>	0.63 (16.0)	2.37 (60.2)	—	2.59 (65.7)	2.88 (73.2)

#### Notes

- ① For ordering information, see [Page V7-T42-105](#).
- ② For information on Printed Marking Tag Options, see [Page V7-T42-98](#).
- ③ XBUT35PE has an enclosed design. The use of an end cover is not required.

For additional accessories, see [Page V7-T42-90](#).

#### Multi-Conductor Terminal Blocks

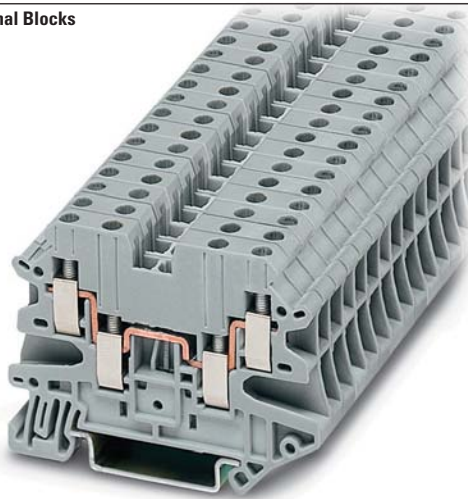

#### Contents

<b>Description</b>	<b>Page</b>
Single Level—Through-Feed . . . . .	<b>V7-T42-5</b>
Single Level—Ground Blocks . . . . .	<b>V7-T42-10</b>
Multi-Conductor Terminal Blocks	
Accessories . . . . .	<b>V7-T42-13</b>
Technical Data and Specifications . . . . .	<b>V7-T42-13</b>
Dimensions . . . . .	<b>V7-T42-13</b>
Multi-Conductor Ground Blocks . . . . .	<b>V7-T42-14</b>
Double Level . . . . .	<b>V7-T42-16</b>
Triple Level Sensor/Actuator . . . . .	<b>V7-T42-18</b>
Fuse Terminal Blocks . . . . .	<b>V7-T42-21</b>
Disconnect and Component Terminal Blocks . . . . .	<b>V7-T42-24</b>
High Current Blocks . . . . .	<b>V7-T42-27</b>
Mini Screw Connection . . . . .	<b>V7-T42-29</b>

### Multi-Conductor Terminal Blocks

#### Product Description

The multi-conductor terminal blocks offer a space-saving alternative to standard feed-through terminal blocks allowing for high density wiring. Often, three

connections have to be led to one terminal block. The XBUT...D12 terminal block accomplishes this without any additional terminal blocks or bridging required.

The XBUT...D22 terminal blocks allow four wires to be connected to one potential—and can therefore be used as compact power distributors.

#### Product Selection

##### XBUT25D12

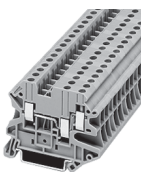

#### Screw Connection Multi-Conductor Terminal Blocks, Three-Wire

Terminal Width	Maximum Wire Size	IEC 60 947-7-1 in V/A/AWG	UL-cUL Ratings in V/A/AWG	Color	Standard Pack	Catalog Number
5.2 mm	12 AWG/2.5 mm <sup>2</sup>	500/28/26-12	150/20/26-12	Gray	50	<b>XBUT25D12</b>
				Blue	50	<b>XBUT25D12BU</b>
6.2 mm	10 AWG/4 mm <sup>2</sup>	500/39/26-10	150/30/26-10	Gray	50	<b>XBUT4D12</b>
				Blue	50	<b>XBUT4D12BU</b>

##### XBUT4D22



#### Screw Connection Multi-Conductor Terminal Blocks, Four-Wire

Terminal Width	Maximum Wire Size	IEC 60 947-7-1 in V/A/AWG	UL-cUL Ratings in V/A/AWG	Color	Standard Pack	Catalog Number
5.2 mm	12 AWG/2.5 mm <sup>2</sup>	500/28/26-12	150/20/26-12	Gray	50	<b>XBUT25D22</b>
				Blue	50	<b>XBUT25D22BU</b>
6.2 mm	10 AWG/4 mm <sup>2</sup>	500/39/26-10	150/30/26-10	Gray	50	<b>XBUT4D22</b>
				Blue	50	<b>XBUT4D22BU</b>

## Accessories

### Screw Connection Multi-Conductor Terminal Blocks

Description	Color	Number of Positions	Standard Pack	XBUT25D12	XBUT4D12	XBUT25D22	XBUT4D22
				Catalog Number	Catalog Number	Catalog Number	Catalog Number
End cover	Gray	—	10	<b>XBACUT4D12</b>	<b>XBACUT4D12</b>	<b>XBACUT4D22</b>	<b>XBACUT4D22</b>
End cover segment	Gray	—	10	<b>XBASUT4</b>	<b>XBASUT4</b>	<b>XBASUT4</b>	<b>XBASUT4</b>
Partition plate	—	—	10	<b>XBATUTD12</b>	<b>XBATUTD12</b>	<b>XBATUTD22</b>	<b>XBATUTD22</b>
Plug-in bridge—for cross connections in the bridge shaft	Red	2	10	<b>XBAFBS25</b>	<b>XBAFBS26</b>	<b>XBAFBS25</b>	<b>XBAFBS26</b>
		3	10	<b>XBAFBS35</b>	<b>XBAFBS36</b>	<b>XBAFBS35</b>	<b>XBAFBS36</b>
		5	10	<b>XBAFBS55</b>	<b>XBAFBS56</b>	<b>XBAFBS55</b>	<b>XBAFBS56</b>
		10	10	<b>XBAFBS105</b>	<b>XBAFBS106</b>	<b>XBAFBS105</b>	<b>XBAFBS106</b>
		50	10	<b>XBAFBS505</b>	<b>XBAFBS506</b>	<b>XBAFBS505</b>	<b>XBAFBS506</b>
Test adapter	—	—	10	<b>XBATSPAI4</b>	<b>XBATSPAI4</b>	<b>XBATSPAI4</b>	<b>XBATSPAI4</b>
2.3 mm diameter test plug	—	—	—	<b>XBATSMPS-<sup>①</sup></b>	<b>XBATSMPS-<sup>①</sup></b>	<b>XBATSMPS-<sup>①</sup></b>	<b>XBATSMPS-<sup>①</sup></b>
Modular test plug	—	—	10	<b>XBATSPS5</b>	<b>XBATSPS6</b>	<b>XBATSPS5</b>	<b>XBATSPS6</b>
Blank marker strip (strip of 10)	White	—	10	<b>XBMZB5<sup>②</sup></b>	<b>XBMZB6<sup>②</sup></b>	<b>XBMZB5<sup>②</sup></b>	<b>XBMZB6<sup>②</sup></b>

## Technical Data and Specifications

### Screw Connection Multi-Conductor Terminal Blocks

Description	XBUT25D12	XBUT4D12	XBUT25D22	XBUT4D22
<b>Technical Data in Accordance with IEC</b>				
Maximum load current in A/cross-section in mm <sup>2</sup>	28/4	39/6	28/4	39/6
Rated surge voltage in kV/contamination class	6/3	6/3	6/3	6/3
Surge voltage category/insulating material group	III/I	III/I	III/I	III/I
<b>Connection Capacity</b>				
Stranded with ferrule/with ferrule and plastic sleeve in mm <sup>2</sup>	0.25–2.5/0.25–2.5	0.25–4/0.25–4	0.25–2.5/0.25–2.5	0.25–4/0.25–4
<b>Multi-Conductor Connection</b> (same cross-section)				
Solid/stranded in mm <sup>2</sup>	0.14–1.0/0.14–1.0	0.14–1.0/0.14–1.5	0.14–1.0/0.14–1.0	0.14–1.0/0.14–1.5
Stranded with ferrules without plastic sleeve in mm <sup>2</sup>	0.25–1.0	0.25–1.5	0.25–1.0	0.25–1.5
Stranded with twin ferrule with plastic sleeve in mm <sup>2</sup>	0.5–1.0	0.5–1.0	0.5–1.0	0.5–1.0
Stripping length in inches (mm)	0.31 (8)	0.31 (8)	0.31 (8)	0.31 (8)
Thread	M3	M3	M3	M3
Torque in in-lb (Nm)	5.3–7.1 (0.6–0.8)	5.3–7.1 (0.6–0.8)	5.3–7.1 (0.6–0.8)	5.3–7.1 (0.6–0.8)

## Dimensions

Approximate Dimensions in Inches (mm)

### Screw Connection Multi-Conductor Terminal Blocks

Catalog Number	Width	Length	Cover Width	Height for—	
				35 x 7.5 in	35 x 15 in
<b>XBUT25D12</b>	0.20 (5.2)	2.24 (56.8)	0.09 (2.2)	1.87 (47.5)	2.17 (55.0)
<b>XBUT4D12</b>	0.24 (6.2)	2.24 (56.8)	0.09 (2.2)	1.87 (47.5)	2.17 (55.0)
<b>XBUT25D22</b>	0.20 (5.2)	2.52 (64.1)	0.09 (2.2)	1.87 (47.5)	2.17 (55.0)
<b>XBUT4D22</b>	0.24 (6.2)	2.52 (64.1)	0.09 (2.2)	1.87 (47.5)	2.17 (55.0)

#### Notes

<sup>①</sup> For ordering information, see **Page V7-T42-105**.

<sup>②</sup> For information on Printed Marking Tag Options, see **Page V7-T42-98**.

For additional accessories, see **Page V7-T42-90**.

#### Multi-Conductor Ground Blocks

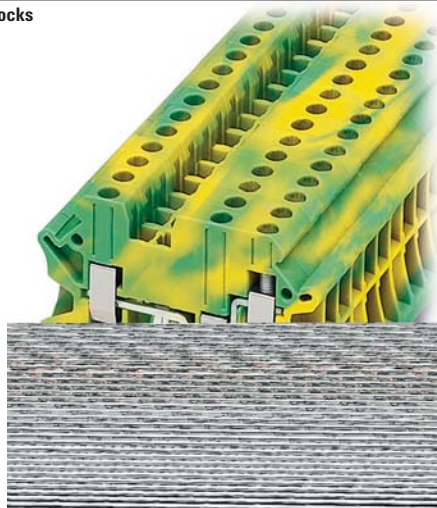

#### Contents

<b>Description</b>	<b>Page</b>
Single Level—Through-Feed .....	<b>V7-T42-5</b>
Single Level—Ground Blocks .....	<b>V7-T42-10</b>
Multi-Conductor Terminal Blocks .....	<b>V7-T42-12</b>
Multi-Conductor Ground Blocks	
Accessories .....	<b>V7-T42-15</b>
Technical Data and Specifications .....	<b>V7-T42-15</b>
Dimensions .....	<b>V7-T42-15</b>
Double Level .....	<b>V7-T42-16</b>
Triple Level Sensor/Actuator .....	<b>V7-T42-18</b>
Fuse Terminal Blocks .....	<b>V7-T42-21</b>
Disconnect and Component Terminal Blocks .....	<b>V7-T42-24</b>
High Current Blocks .....	<b>V7-T42-27</b>
Mini Screw Connection .....	<b>V7-T42-29</b>

### Multi-Conductor Ground Blocks

#### Product Description

The ground terminal blocks have the same shape and pitch as the standard terminal block, in a green-yellow housing. They easily snap

onto the DIN rail to make a reliable mechanical and electrical contact that meets all requirements of IEC 60-947-7-2.

#### Product Selection

##### XBUT4D12PE



#### Screw Connection Multi-Conductor Ground Blocks—Three-Wire

Terminal Width	Maximum Wire Size	IEC 60 947-7-1 in V/A/AWG	UL-cUL Ratings in V/A/AWG	Color	Standard Pack	Catalog Number
5.2 mm	12 AWG/2.5 mm <sup>2</sup>	—/—/26-12	—/—/26-12	Green/Yellow	50	<b>XBUT25D12PE</b>
6.2 mm	10 AWG/4 mm <sup>2</sup>	—/—/26-10	—/—/26-10	Green/Yellow	50	<b>XBUT4D12PE</b>

##### XBUT25D22PE



#### Screw Connection Multi-Conductor Ground Blocks—Four-Wire

Terminal Width	Maximum Wire Size	IEC 60 947-7-1 in V/A/AWG	UL-cUL Ratings in V/A/AWG	Color	Standard Pack	Catalog Number
5.2 mm	12 AWG/2.5 mm <sup>2</sup>	—/—/26-12	—/—/26-12	Green/Yellow	50	<b>XBUT25D22PE</b>
6.2 mm	10 AWG/4 mm <sup>2</sup>	—/—/26-10	—/—/26-10	Green/Yellow	50	<b>XBUT4D22PE</b>

## Accessories

### Screw Connection Multi-Conductor Ground Blocks

Description	Color	Number of Positions	Standard Pack	XBUT25D12PE		XBUT4D12PE		XBUT25D22PE		XBUT4D22PE	
				Catalog Number	Catalog Number	Catalog Number	Catalog Number	Catalog Number	Catalog Number		
End cover	Gray	—	10	<b>XBACUT4D12</b>	<b>XBACUT4D12</b>	<b>XBACUT4D22</b>	<b>XBACUT4D22</b>	<b>XBACUT4D12</b>	<b>XBACUT4D12</b>	<b>XBACUT4D22</b>	<b>XBACUT4D22</b>
End cover segment	Gray	—	10	<b>XBASUT4</b>	<b>XBASUT4</b>	<b>XBASUT4</b>	<b>XBASUT4</b>	<b>XBASUT4</b>	<b>XBASUT4</b>	<b>XBASUT4</b>	<b>XBASUT4</b>
Partition plate	—	—	10	<b>XBATUTD12</b>	<b>XBATUTD12</b>	<b>XBATUTD22</b>	<b>XBATUTD22</b>	<b>XBATUTD12</b>	<b>XBATUTD12</b>	<b>XBATUTD22</b>	<b>XBATUTD22</b>
Plug-in bridge—for cross connections in the bridge shaft	Red	2	10	<b>XBAFBS25</b>	<b>XBAFBS26</b>	<b>XBAFBS25</b>	<b>XBAFBS25</b>	<b>XBAFBS26</b>	<b>XBAFBS26</b>	<b>XBAFBS25</b>	<b>XBAFBS26</b>
		3	10	<b>XBAFBS35</b>	<b>XBAFBS36</b>	<b>XBAFBS35</b>	<b>XBAFBS35</b>	<b>XBAFBS36</b>	<b>XBAFBS36</b>	<b>XBAFBS35</b>	<b>XBAFBS36</b>
		5	10	<b>XBAFBS55</b>	<b>XBAFBS56</b>	<b>XBAFBS55</b>	<b>XBAFBS55</b>	<b>XBAFBS56</b>	<b>XBAFBS56</b>	<b>XBAFBS55</b>	<b>XBAFBS56</b>
		10	10	<b>XBAFBS105</b>	<b>XBAFBS106</b>	<b>XBAFBS105</b>	<b>XBAFBS105</b>	<b>XBAFBS106</b>	<b>XBAFBS106</b>	<b>XBAFBS105</b>	<b>XBAFBS106</b>
		50	10	<b>XBAFBS505</b>	<b>XBAFBS506</b>	<b>XBAFBS505</b>	<b>XBAFBS505</b>	<b>XBAFBS506</b>	<b>XBAFBS506</b>	<b>XBAFBS505</b>	<b>XBAFBS506</b>
Test adapter	—	—	10	<b>XBATSPA14</b>	<b>XBATSPA14</b>	<b>XBATSPA14</b>	<b>XBATSPA14</b>	<b>XBATSPA14</b>	<b>XBATSPA14</b>	<b>XBATSPA14</b>	<b>XBATSPA14</b>
2.3 mm diameter test plug	—	—	—	<b>XBATSMPS-<sup>①</sup></b>	<b>XBATSMPS-<sup>①</sup></b>	<b>XBATSMPS-<sup>①</sup></b>	<b>XBATSMPS-<sup>①</sup></b>	<b>XBATSMPS-<sup>①</sup></b>	<b>XBATSMPS-<sup>①</sup></b>	<b>XBATSMPS-<sup>①</sup></b>	<b>XBATSMPS-<sup>①</sup></b>
Modular test plug	—	—	10	<b>XBATSPS5</b>	<b>XBATSPS6</b>	<b>XBATSPS5</b>	<b>XBATSPS5</b>	<b>XBATSPS6</b>	<b>XBATSPS6</b>	<b>XBATSPS5</b>	<b>XBATSPS6</b>
Blank marker strip (strip of 10)	White	—	10	<b>XBMZB5<sup>②</sup></b>	<b>XBMZB6<sup>②</sup></b>	<b>XBMZB5<sup>②</sup></b>	<b>XBMZB5<sup>②</sup></b>	<b>XBMZB6<sup>②</sup></b>	<b>XBMZB6<sup>②</sup></b>	<b>XBMZB5<sup>②</sup></b>	<b>XBMZB6<sup>②</sup></b>

## Technical Data and Specifications

### Screw Connection Multi-Conductor Ground Blocks

Description	XBUT25D12PE	XBUT4D12PE	XBUT25D22PE	XBUT4D22PE
<b>Technical Data in Accordance with IEC</b>				
Maximum load current in A/cross-section in mm <sup>2</sup>	—	—	—	—
Rated surge voltage in kV/contamination class	6/3	6/3	6/3	6/3
Surge voltage category/insulating material group	III/I	III/I	III/I	III/I
<b>Connection Capacity</b>				
Stranded with ferrule/with ferrule and plastic sleeve in mm <sup>2</sup>	0.25–2.5/0.25–2.5	0.25–4/0.25–4	0.25–2.5/0.25–2.5	0.25–4/0.25–4
<b>Multi-Conductor Connection</b> (same cross-section)				
Solid/stranded in mm <sup>2</sup>	0.14–1.0/0.14–1.0	0.14–1.0/0.14–1.5	0.14–1.0/0.14–1.0	0.14–1.0/0.14–1.5
Stranded with ferrules without plastic sleeve in mm <sup>2</sup>	0.25–1.0	0.25–1.5	0.25–1.0	0.25–1.5
Stranded with twin ferrule with plastic sleeve in mm <sup>2</sup>	0.5–1.0	0.5–1.0	0.5–1	0.5–1
Stripping length in inches (mm)	0.31 (8)	0.31 (8)	0.31 (8)	0.31 (8)
Thread	M3	M3	M3	M3
Torque in in-lb (Nm)	5.3–7.1 (0.6–0.8)	5.3–7.1 (0.6–0.8)	5.3–7.1 (0.6–0.8)	5.3–7.1 (0.6–0.8)

## Dimensions

Approximate Dimensions in Inches (mm)

### Screw Connection Multi-Connector Ground Blocks

Catalog Number	Width	Length	Cover Width	Height for—	
				35 x 7.5 in	35 x 15 in
<b>XBUT25D12PE</b>	0.20 (5.2)	2.24 (56.8)	0.09 (2.2)	1.87 (47.5)	2.17 (55.0)
<b>XBUT4D12PE</b>	0.20 (5.2)	2.24 (56.8)	0.09 (2.2)	1.87 (47.5)	2.17 (55.0)
<b>XBUT25D22PE</b>	0.20 (5.2)	2.52 (64.1)	0.09 (2.2)	1.87 (47.5)	2.17 (55.0)
<b>XBUT4D22PE</b>	0.24 (6.2)	2.52 (64.1)	0.09 (2.2)	1.87 (47.5)	2.17 (55.0)

#### Notes

<sup>①</sup> For ordering information, see [Page V7-T42-105](#).

<sup>②</sup> For information on Printed Marking Tag Options, see [Page V7-T42-98](#).

For additional accessories, see [Page V7-T42-90](#).



Double Level



### Contents

<i>Description</i>	<i>Page</i>
Single Level—Through-Feed . . . . .	<b>V7-T42-5</b>
Single Level—Ground Blocks . . . . .	<b>V7-T42-10</b>
Multi-Conductor Terminal Blocks . . . . .	<b>V7-T42-12</b>
Multi-Conductor Ground Blocks . . . . .	<b>V7-T42-14</b>
Double Level	
Accessories . . . . .	<b>V7-T42-17</b>
Technical Data and Specifications . . . . .	<b>V7-T42-17</b>
Dimensions . . . . .	<b>V7-T42-17</b>
Triple Level Sensor/Actuator . . . . .	<b>V7-T42-18</b>
Fuse Terminal Blocks . . . . .	<b>V7-T42-21</b>
Disconnect and Component Terminal Blocks . . . . .	<b>V7-T42-24</b>
High Current Blocks . . . . .	<b>V7-T42-27</b>
Mini Screw Connection . . . . .	<b>V7-T42-29</b>

### Double Level

#### Product Description

The potentials of the XBUTT double-level terminal blocks are on two levels to reduce space requirements by 50% over single-level terminal

blocks. The XBUTT Series can be bridged on both levels for maximum flexibility. Marking can be provided at each termination point.

#### Product Selection

**XBUTT4**

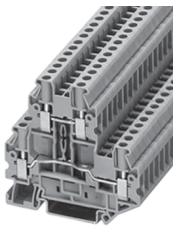

#### Screw Connection Double Level Blocks, XBUTT4

Terminal Width	Maximum Wire Size	IEC 60 947-7-1 in V/A/AWG	UL-cUL Ratings in V/A/AWG	Color	Standard Pack	Catalog Number
<b>Screw Connection Double Level Blocks</b>						
6.2 mm	10 AWG/4 mm <sup>2</sup>	800/36/26–10	300/30/26–10	Gray	50	<b>XBUTT4</b>
				Blue	50	<b>XBUTT4BU</b>
				Red	50	<b>XBUTT4RD</b>
<b>Screw Connection Double Level Block</b> (terminal block with potential distribution between the levels)						
6.2 mm	10 AWG/4 mm <sup>2</sup>	800/36/26–10	300/30/26–10	Gray	50	<b>XBUTT4PV</b>

**XBUTT4PE**



#### Screw Connection Double Level Ground Block, XBUTT4PE

Terminal Width	Maximum Wire Size	IEC 60 947-7-1 in V/A/AWG	UL-cUL Ratings in V/A/AWG	Color	Standard Pack	Catalog Number
<b>Screw Connection Double Level—Ground Blocks</b>						
6.2 mm	10 AWG/4 mm <sup>2</sup>	—/—/26–10	—/—/26–10	Green/Yellow	50	<b>XBUTT4PE</b>



## Accessories

### Screw Connection Terminal/Ground Blocks, Double Level

Description	Color	Number of Positions	Standard Pack	XBUTT4 Catalog Number	XBUTT4PE Catalog Number
End cover	Gray	—	10	<b>XBACUTT4</b>	<b>XBACUTT4</b>
End cover segment	Gray	—	10	<b>XBDPUTT4</b>	<b>XBDPUTT4</b>
Partition plate	—	—	10	<b>XBATUTT4</b>	<b>XBATUTT4</b>
Plug-in bridge—for cross connections in the bridge shaft	Red	2	10	<b>XBAFBS26</b>	<b>XBAFBS26</b>
		3	10	<b>XBAFBS36</b>	<b>XBAFBS36</b>
		5	10	<b>XBAFBS56</b>	<b>XBAFBS56</b>
		10	10	<b>XBAFBS106</b>	<b>XBAFBS106</b>
		50	10	<b>XBAFBS506</b>	<b>XBAFBS506</b>
Test adapter	—	—	10	<b>XBATSPA14</b>	<b>XBATSPA14</b>
2.3 mm diameter test plug	—	—	—	<b>XBATSMPS-</b> <sup>①</sup>	<b>XBATSMPS-</b> <sup>①</sup>
Modular test plug	—	—	10	<b>XBATSPS6</b>	<b>XBATSPS6</b>
Blank marker strip (strip of 10)	White	—	10	<b>XBMZB6</b> <sup>②</sup>	<b>XBMZB6</b> <sup>②</sup>

## Technical Data and Specifications

### Screw Connection Double Level

Description	XBUTT4	XBUTT4PE
<b>Technical Data in Accordance with IEC</b>		
Maximum load current in A/cross-section in mm <sup>2</sup>	30/6	—/6
Rated surge voltage in kV/contamination class	8/3	6/3
Surge voltage category/insulating material group	III/I	III/I
<b>Connection Capacity</b>		
Stranded with ferrule/with ferrule and plastic sleeve in mm <sup>2</sup>	0.25–4/0.25–4	0.25–4/0.25–4
<b>Multi-Conductor Connection</b> (same cross-section)		
Solid/stranded in mm <sup>2</sup>	0.14–1.5/0.14–1.5	0.14–1.5/0.14–1.5
Stranded with ferrules without plastic sleeve in mm <sup>2</sup>	0.25–1.5	0.25–1.5
Stranded with twin ferrule with plastic sleeve in mm <sup>2</sup>	0.5–2.5	0.5–2.5
Stripping length in inches (mm)	0.35 (9)	0.35 (9)
Thread	M3	M3
Torque in in-lb (Nm)	5.3–7.1 (0.6–0.8)	5.3–7.1 (0.6–0.8)

## Dimensions

Approximate Dimensions in Inches (mm)

### Screw Connection Double Level

Catalog Number	Width	Length	Cover Width	Height for—	
				35 x 7.5 in	35 x 15 in
<b>XBUTT4</b>	0.24 (6.2)	2.75 (69.9)	0.09 (2.2)	2.56 (65.0)	2.85 (72.5)
<b>XBUTT4PE</b>	0.24 (6.2)	2.75 (69.9)	0.09 (2.2)	2.56 (65.0)	2.85 (72.5)

#### Notes

① For ordering information, see **Page V7-T42-105**.

② For information on Printed Marking Tag Options, see **Page V7-T42-98**.

For additional accessories, see **Page V7-T42-90**.

Triple Level Sensor/Actuator

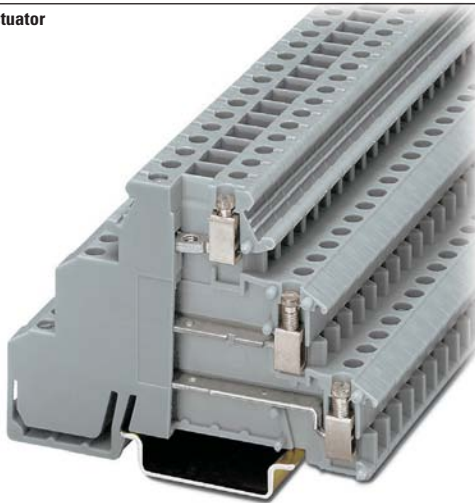

### Contents

<i>Description</i>	<i>Page</i>
Single Level—Through-Feed .....	<b>V7-T42-5</b>
Single Level—Ground Blocks .....	<b>V7-T42-10</b>
Multi-Conductor Terminal Blocks .....	<b>V7-T42-12</b>
Multi-Conductor Ground Blocks .....	<b>V7-T42-14</b>
Double Level .....	<b>V7-T42-16</b>
Triple Level Sensor/Actuator	
Accessories .....	<b>V7-T42-19</b>
Technical Data and Specifications .....	<b>V7-T42-20</b>
Dimensions .....	<b>V7-T42-20</b>
Fuse Terminal Blocks .....	<b>V7-T42-21</b>
Disconnect and Component Terminal Blocks .....	<b>V7-T42-24</b>
High Current Blocks .....	<b>V7-T42-27</b>
Mini Screw Connection .....	<b>V7-T42-29</b>

### Triple Level Sensor/Actuator

#### Product Description

The XB3UK sensor terminal blocks reduce installation time by terminating three-wire devices such as photoelectric and proximity sensors in a single terminal block. The XB3UK Series accommodates a design where the positive and negative connections are

grouped so that only the signal lines and one pair of wires for the power supply need to be wired between the terminal box and the control. The upper level accommodates the markable feed-through terminals for the signal line. The two lower terminal points can be

bridged. These are used for the sensor power supply. The positive and negative potential can be fed into the bridges with XB3UKF25. The first sensor can also be connected to this three-wire feed-through block.

#### Product Selection

XB3UKA25



#### Screw Connection Triple Level Sensor/Actuator

Terminal Width	Maximum Wire Size	Connection Data in V/A/AWG	IEC 60 947-7-1 in V/A/AWG	UL-cUL Ratings in V/A/AWG	Color	Standard Pack	Catalog Number
<b>Screw Connection Triple Level</b>							
6.2 mm	14 AWG/2.5 mm <sup>2</sup>	250/26/24-12	—	300/15/30-14	Gray	50	<b>XB3UKA25</b>
<b>Screw Connection Triple Level with Red LED, 15-30 Vdc, 2.5-7.5A</b>							
6.2 mm	14 AWG/2.5 mm <sup>2</sup>	250/26/24-12	—	300/15/30-14	Gray	50	<b>XB3UKA25L24</b>

XB3UKF25



#### Screw Connection Triple Level Sensor/Actuator

Terminal Width	Maximum Wire Size	Connection Data in V/A/AWG	IEC 60 947-7-1 in V/A/AWG	UL-cUL Ratings in V/A/AWG	Color	Standard Pack	Catalog Number
<b>Screw Connection Triple Level</b>							
6.2 mm	14 AWG/2.5 mm <sup>2</sup>	—	250/30/24-12	300/15/30-14	Gray	50	<b>XB3UKF25</b>

## XB3UKA25PE



## Screw Connection Triple Level Sensor/Actuator

Terminal Width	Maximum Wire Size	Connection Data in V/A/AWG	UL-cUL Ratings in V/A/AWG	Color	Standard Pack	Catalog Number
<b>Screw Connection Triple Level</b>						
6.2 mm	14 AWG/2.5 mm <sup>2</sup>	250/26/24–12	300/15/30–14	Gray	50	<b>XB3UKA25PE</b>
<b>Screw Connection Triple Level with Red LED, 15–30 Vdc, 2.5–7.5A</b>						
6.2 mm	14 AWG/2.5 mm <sup>2</sup>	250/26/24–12	300/15/30–14	Gray	50	<b>XB3UKA25PEL24</b>

## XB3UKF25PE



## Screw Connection Triple Level Sensor/Actuator

Terminal Width	Maximum Wire Size	Connection Data in V/A/AWG	UL-cUL Ratings in V/A/AWG	Color	Standard Pack	Catalog Number
<b>Screw Connection Triple Level</b>						
6.2 mm	14 AWG/2.5 mm <sup>2</sup>	—	300/15/30–14	Gray	50	<b>XB3UKF25PE</b>

## Accessories

## Screw Connection Triple Level Sensor/Actuator

Description	Color	Number of Positions	Standard Pack	XB3UKA25	XB3UKF25	XB3UKA25PE	XB3UKF25PE
				Catalog Number	Catalog Number	Catalog Number	Catalog Number
Insertion bridge	Blue	80	1	<b>XBAEB80DIKB</b>	<b>XBAEB80DIKB</b>	<b>XBAEB80DIKB</b>	<b>XBAEB80DIKB</b>
	Red	80	1	<b>XBAEB80DIKR</b>	<b>XBAEB80DIKR</b>	<b>XBAEB80DIKR</b>	<b>XBAEB80DIKR</b>
Insertion bridge	Blue	10	10	<b>XBAEB10DIKB</b>	<b>XBAEB10DIKB</b>	<b>XBAEB10DIKB</b>	<b>XBAEB10DIKB</b>
	Red	10	10	<b>XBAEB10DIKR</b>	<b>XBAEB10DIKR</b>	<b>XBAEB10DIKR</b>	<b>XBAEB10DIKR</b>
Blank marker strip (strip of 10)	White	—	10	<b>XBMZB6</b> ①	<b>XBMZB6</b> ②	<b>XBMZB6</b> ②	<b>XBMZB6</b> ②

## Notes

① For information on Printed Marking Tag Options, see **Page V7-T42-98**.

For additional accessories, see **Page V7-T42-90**.

#### Technical Data and Specifications

##### Screw Connection Triple Level Sensor/Actuator

Description	XB3UKA25	XB3UKF25	XB3UKA25PE	XB3UKF25PE
<b>Technical Data in Accordance with IEC</b>				
Maximum load current in A/cross-section in mm <sup>2</sup>	26/2.5	30/4	26/2.5	26/2.5
Maximum cross section with insertion bridge solid/stranded in mm <sup>2</sup>	4/2.5	4/2.5	4/2.5	4/2.5
Rated surge voltage in kV/contamination class	4/3	4/3	4/3	6/3
Surge voltage category/insulating material group	III/1	III/1	III/1	III/1
<b>Connection Capacity</b>				
Stranded with ferrule/with ferrule and plastic sleeve in mm <sup>2</sup>	0.25–2.5/0.25–2.5	0.25–2.5/0.25–2.5	0.25–2.5/0.25–2.5	0.25–2.5/0.25–2.5
<b>Multi-Conductor Connection</b> (same cross-section)				
Solid/stranded in mm <sup>2</sup>	0.2–1.0/0.2–1.0	0.2–1.0/0.2–1.0	0.2–1.0/0.2–1.0	0.2–1.0/0.2–1.0
Stranded with ferrules without plastic sleeve in mm <sup>2</sup>	0.25–1.0	0.25–1.0	0.25–1.0	0.25–1.0
Stranded with twin ferrule with plastic sleeve in mm <sup>2</sup>	0.5–1.0	0.5–1.0	0.5–1.0	0.5–1.0
Stripping length in inches (mm)	0.31 (8)	0.31 (8)	0.31 (8)	0.31 (8)
Thread	M3	M3	M3	M3
Torque in in-lb (Nm)	4.4–5.3 (0.5–0.6)	4.4–5.3 (0.5–0.6)	4.4–5.3 (0.5–0.6)	4.4–5.3 (0.5–0.6)

42

##### Wiring for Three-Level Sensor Terminal Blocks

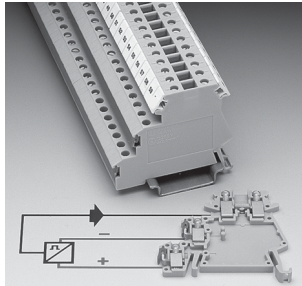

##### Wiring for Four-Level Sensor Terminal Blocks

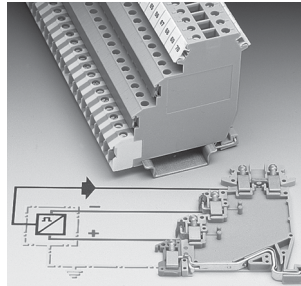

#### Dimensions

Approximate Dimensions in Inches (mm)

##### Screw Connection Triple Level Sensor/Actuator

Catalog Number	Width	Length	Height for—	
			35 x 7.5 in	35 x 15 in
XB3UKA25	0.24 (6.2)	2.17 (55.0)	2.15 (54.5)	2.44 (62.0)
XB3UKF25	0.24 (6.2)	2.85 (72.5)	2.15 (54.5)	2.44 (62.0)
XB3UKA25PE	0.24 (6.2)	2.46 (62.5)	2.76 (70.0)	3.05 (77.5)
XB3UKF25PE	0.24 (6.2)	3.25 (82.5)	2.76 (70.0)	3.05 (77.5)

## Fuse Terminal Blocks



## Contents

<b>Description</b>	<b>Page</b>
Single Level—Through-Feed .....	<b>V7-T42-5</b>
Single Level—Ground Blocks .....	<b>V7-T42-10</b>
Multi-Conductor Terminal Blocks .....	<b>V7-T42-12</b>
Multi-Conductor Ground Blocks .....	<b>V7-T42-14</b>
Double Level.....	<b>V7-T42-16</b>
Triple Level Sensor/Actuator .....	<b>V7-T42-18</b>
Fuse Terminal Blocks	
Accessories .....	<b>V7-T42-23</b>
Technical Data and Specifications .....	<b>V7-T42-23</b>
Dimensions .....	<b>V7-T42-23</b>
Disconnect and Component Terminal Blocks .....	<b>V7-T42-24</b>
High Current Blocks .....	<b>V7-T42-27</b>
Mini Screw Connection .....	<b>V7-T42-29</b>

## Fuse Terminal Blocks

### Product Description

The UT Series fuse terminal blocks come in two varieties—lever type and cap. Each performs two functions. They act as a fuse carrier for most common North American and European fuses and they

allow for potential distribution with the double bridge shaft. The terminal blocks therefore allow bypass routing of two separate potentials next to each other. This has the advantage of a time-saving

potential infeed and a correct, functional configuration of the terminal strip. For signaling a triggered fuse, fuse terminal blocks with light indicators are available (for both AC and DC voltage).

### Product Selection

#### XBUT4FBE



### Screw Connection Fuse Terminal Blocks, for 5 x 20 mm Fuse

Terminal Width	Maximum Wire Size	IEC 60 947-7-3 in V/A/AWG	UL-cUL Ratings in V/A/AWG	Color	Standard Pack	Catalog Number
<b>Fuse Terminal Blocks</b>						
6.2 mm	10 AWG/4 mm <sup>2</sup>	①/6.3/26–10	600/6.3/26–10	Black	50	<b>XBUT4FBE</b>
<b>Fuse Terminal Blocks with LED 12–30V, 1–2.5 mA</b>						
6.2 mm	10 AWG/4 mm <sup>2</sup>	①/6.3/26–10	600/6.3/26–10	Black	50	<b>XBUT4FBEL24</b>
<b>Fuse Terminal Blocks with LED 30–60V, 0.8–2.0 mA</b>						
6.2 mm	10 AWG/4 mm <sup>2</sup>	①/6.3/26–10	600/6.3/26–10	Black	50	<b>XBUT4FBEL60</b>
<b>Fuse Terminal Blocks with LED 110–250V, 0.5–2.5 mA</b>						
6.2 mm	10 AWG/4 mm <sup>2</sup>	①/6.3/26–10	600/6.3/26–10	Black	50	<b>XBUT4FBEL250</b>

#### Note

① As disconnect terminal block 400V, as fuse terminal block 250V.

#### XBUT6FBN



#### Screw Connection Fuse Terminal Blocks for 6.3 x 32 mm (1/4 in x 1-1/4 in) Fuse

Terminal Width	Maximum Wire Size	IEC 60 947-7-3 in V/A/AWG	UL-cUL Ratings in V/A/AWG	Color	Standard Pack	Catalog Number
<b>Fuse Terminal Blocks</b>						
8.2 mm	8 AWG/6 mm <sup>2</sup>	①/10/24-8	400/10/24-8	Black	50	<b>XBUT6FBN</b>
<b>Fuse Terminal Blocks with LED 12-30V, 1-2.5 mA</b>						
8.2 mm	8 AWG/6 mm <sup>2</sup>	①/10/24-8	400/10/24-8	Black	50	<b>XBUT6FBNL24</b>
<b>Fuse Terminal Blocks with LED 30-60V, 0.8-2.0 mA</b>						
8.2 mm	8 AWG/6 mm <sup>2</sup>	①/10/24-8	400/10/24-8	Black	50	<b>XBUT6FBNL60</b>
<b>Fuse Terminal Blocks with LED 110-250V, 0.5-2.5 mA</b>						
8.2 mm	8 AWG/6 mm <sup>2</sup>	①/10/24-8	400/10/24-8	Black	50	<b>XBUT6FBNL250</b>

#### XBUK10FBCE



#### Screw Connection Fuse Terminal Blocks, XBUK10FBC

Terminal Width	Maximum Wire Size	IEC 60 947-7-3 with Fuse in V/A/AWG	IEC 60 947-7-3 as Disconnected t.b. in V/A/AWG	UL-cUL Ratings in V/A/AWG	Color	Standard Pack	Catalog Number
<b>Fuse Terminal Blocks for 5 x 20 mm fuse</b>							
12 mm	6 AWG/16 mm <sup>2</sup>	①/①/20-4	800/10/20-6	300/20/22-6	Black	50	<b>XBUK10FBCE</b>
<b>Fuse Terminal Blocks for 6.3 x 32 mm (1/4 in x 1-1/4 in) fuse</b>							
12 mm	6 AWG/16 mm <sup>2</sup>	①/①/20-4	800/10/20-6	300/20/22-6	Black	50	<b>XBUK10FBCN</b>
<b>Fuse Terminal Blocks with Light Indicator 15-30V, 1-2.5 mA, 5 x 20 mm</b>							
12 mm	6 AWG/16 mm <sup>2</sup>	①/①/20-4	800/10/20-6	300/20/22-6	Black	50	<b>XBUK10FBCEL24</b>
<b>Fuse Terminal Blocks with Light Indicator 15-30V, 1-2.5 mA, 6.3 x 32 mm</b>							
12 mm	6 AWG/16 mm <sup>2</sup>	①/①/20-4	800/10/20-6	300/20/22-6	Black	50	<b>XBUK10FBCNL24</b>
<b>Fuse Terminal Blocks with Light Indicator 110-250V, 0.5-1.1A, 5 x 20 mm</b>							
12 mm	6 AWG/16 mm <sup>2</sup>	①/①/20-4	800/10/20-6	300/20/22-6	Black	50	<b>XBUK10FBCEL250</b>
<b>Fuse Terminal Blocks with Light Indicator 110-250V, 0.5-1.1A, 6.3 x 32 mm</b>							
12 mm	6 AWG/16 mm <sup>2</sup>	①/①/20-4	800/10/20-6	300/20/22-6	Black	50	<b>XBUK10FBCNL250</b>

#### Cartridge Fuse Inserts 5 x 20 mm Based on DIN EN 60 947-7-3: 2003-7

Terminal Blocks	U (V)	Overload Protection		Short-Circuit Protection Only		I <sub>max.</sub> (A)
		Individual	Interconnected	Individual	Interconnected	
<b>XBUT4FBE</b>	250	1.6W	1.6W	4W	2.5W	6.3

#### Notes

Max. power dissipation at 73.4°F (23°C) based on DIN EN 60 947-7-3: 2003-7.

When selecting cartridge fuse inserts, please ensure that the maximum power dissipation specified above is not exceeded. Details can be obtained from the fuse suppliers.

If the fuse is defective, the downstream circuit is not off load.

① As disconnect terminal block 500V, as fuse terminal block 400V.

## Accessories

### Screw Connection Fuse Terminal Blocks

Description	Color	Number of Positions	Standard Pack	XBUT4FBE Catalog Number	XBUT6FBN Catalog Number	XBUK10FBCE Catalog Number
End cover	—	—	—	①	①	—
Plug-in bridge—for cross connections in the bridge shaft	Red	2	10	XBAFBS26	XBAFBS28	—
		3	10	XBAFBS36	XBAFBS38	—
		5	10	XBAFBS56	XBAFBS58	—
		10	10	XBAFBS106	XBAFBS108	—
		50	10	XBAFBS506	XBAFBS508	—
Blank marker strip center labeling (strip of 10)	White	—	—	XBMZB5 ②	XBMZB6 ②	—
Blank marker strip external labeling (strip of 10)	White	—	—	XBMZB6 ②	XBMZB8 ②	—
Fixed bridge	—	2	10	—	—	XBAFBI212
Screw heads with insulating collar	—	10	10	—	—	XBAFBI1012
Blank marker strip (strip of 10)	White	—	10	—	—	XBMZB6 ②

## Technical Data and Specifications

### Screw Connection Fuse Terminal Blocks

Description	XBUT4FBE	XBUT4FBN	XBUK10FBCE
<b>Technical Data in Accordance with IEC</b>			
Fuse type/dimensions in (mm)	—	—	G/5 x 20/5 x 25/6.3 x 32
Maximum cross section with insertion bridge solid/stranded in mm <sup>2</sup>	6.3/6	10/10	10/10
Rated surge voltage in kV/contamination class	4/3	4/3	4/3
Surge voltage category/insulating material group	III/II	III/II	III/I
<b>Connection Capacity</b>			
Stranded with ferrule/with ferrule and plastic sleeve in mm <sup>2</sup>	0.25–4/0.25–4	0.25–6/0.25–6	0.5–10/0.5–10
<b>Multi-Conductor Connection</b> (same cross-section)			
Solid/stranded in mm <sup>2</sup>	0.14–1.5/0.14–1.5	—	0.5–4/0.5–4
Stranded with ferrules without plastic sleeve in mm <sup>2</sup>	0.25–1.5	—	0.5–4
Stranded with twin ferrule with plastic sleeve in mm <sup>2</sup>	0.5–2.5	0.5–4	0.5–10
Stripping length in inches (mm)	0.35 (9)	0.39 (10)	0.43 (11)
Thread	M3	M4	M4
Torque in in-lb (Nm)	5.3–7.1 (0.6–0.8)	13.3–15.9 (1.5–1.8)	13.3–15.9 (1.5–1.8)

## Dimensions

Approximate Dimensions in Inches (mm)

### Screw Connection Fuse Terminal Blocks

Catalog Number	Width	Length	Height for—		
			35 x 7.5 in	35 x 15 in	32 in
XBUT4FBE	0.24 (6.2)	2.24 (56.8)	2.87 (73.0)	3.17 (80.5)	—
XBUT4FBN	0.32 (8.2)	2.24 (56.8)	2.87 (73.0)	3.17 (80.5)	—
XBUK10FBCE	0.47 (12.0)	2.44 (62.0)	2.32 (59.0)	2.62 (66.5)	2.52 (64.0)

#### Notes

① XBUT4FBE and XBUT6FBN have an enclosed design. The use of an end cover is not required.

② For information on Printed Marking Tag Options, see **Page V7-T42-98**.

For additional accessories, see **Page V7-T42-90**.

Disconnect and Component Terminal Blocks



### Contents

<i>Description</i>	<i>Page</i>
Single Level—Through-Feed .....	<b>V7-T42-5</b>
Single Level—Ground Blocks .....	<b>V7-T42-10</b>
Multi-Conductor Terminal Blocks .....	<b>V7-T42-12</b>
Multi-Conductor Ground Blocks .....	<b>V7-T42-14</b>
Double Level .....	<b>V7-T42-16</b>
Triple Level Sensor/Actuator .....	<b>V7-T42-18</b>
Fuse Terminal Blocks .....	<b>V7-T42-21</b>
Disconnect and Component Terminal Blocks	
Product Selection .....	<b>V7-T42-25</b>
Accessories .....	<b>V7-T42-26</b>
Technical Data and Specifications .....	<b>V7-T42-26</b>
Dimensions .....	<b>V7-T42-26</b>
High Current Blocks .....	<b>V7-T42-27</b>
Mini Screw Connection .....	<b>V7-T42-29</b>

### Disconnect and Component Terminal Blocks

#### Product Description

The **XB** Series includes application specific terminal blocks like the XBUT4TG disconnect block that accommodates disconnect component and fuse terminal blocks. It can also be bridged with standard terminal blocks via the double bridge shaft. The component plug XBPCO serves to accommodate different components such as resistors or capacitors.

5 x 20 mm fuses can be inserted into the fuse plug XBPFU, also available with light indication. The XBUT4MT knife disconnect terminal block features a compact design and a high current carrying capacity of 16A. Versions with test socket screws provide a test option for 2.3 mm diameter test plugs on both sides of the disconnect point.



## Product Selection

XBUT4TG  
Disconnect

## Screw Connection Disconnect and Component Terminal Blocks

Terminal Width	Maximum Wire Size	Connection Data in V/A/AWG	UL-cUL Ratings for Disconnect in V/A/AWG	UL-cUL Ratings for Disconnect with Test Sockets in V/A/AWG	Color	Standard Pack	Catalog Number
<b>Screw Connection Disconnect</b>							
6.2 mm	10 AWG/4 mm <sup>2</sup>	500/16/26–10	600/16/26–10	300/16/26–10	Gray	50	<b>XBUT4TG</b>
<b>Screw Connection Disconnect with Test Sockets</b>							
6.2 mm	10 AWG/4 mm <sup>2</sup>	500/16/26–10	600/16/26–10	300/16/26–10	Gray	50	<b>XBUT4TGP</b>
<b>Component Plug</b>							
6.2 mm	10 AWG/4 mm <sup>2</sup>	500/16/26–10	600/16/26–10	300/16/26–10	Gray	10	<b>XBPCO</b>
<b>Fuse Plug</b>							
6.2 mm	10 AWG/4 mm <sup>2</sup>	500/16/26–10	600/16/26–10	300/16/26–10	Black	10	<b>XBPFU</b>
<b>Fuse Plug with Light Indicator for 12–30V, 1–2.5 mA</b>							
6.2 mm	10 AWG/4 mm <sup>2</sup>	500/16/26–10	600/16/26–10	300/16/26–10	Black	10	<b>XBPFUL24</b>
<b>Fuse Plug with Light Indicator for 110–250V, 0.5–2.5 mA</b>							
6.2 mm	10 AWG/4 mm <sup>2</sup>	500/16/26–10	600/16/26–10	300/16/26–10	Black	10	<b>XBPFUL250</b>
<b>Screw Connection Disconnect Knife Disconnect</b>							
6.2 mm	10 AWG/4 mm <sup>2</sup>	500/16/26–10	600/16/26–10	300/16/26–10	Gray	50	<b>XBUT4MT</b>
<b>Screw Connection Disconnect Knife Disconnect with Test Sockets</b>							
6.2 mm	10 AWG/4 mm <sup>2</sup>	500/16/26–10	600/16/26–10	300/16/26–10	Gray	50	<b>XBUT4MTP</b>
<b>Screw Connection Terminal Blocks with Integrated Diodes</b>							
6.2 mm	12 AWG/4 mm <sup>2</sup>	500/32/24–10	600/30/26–10	—	Gray	50	<b>XBUKK4DIO</b>

XBTKT25 Thermal  
Electric Voltage

## Screw Connection Thermoelectric Voltage Terminal Blocks

Terminal Width	Maximum Wire Size	Connection Data in V/A/AWG	UL-cUL Ratings in V/A/AWG	Color	Standard Pack	Catalog Number
<b>Copper/Constantan (CU/CUNI44)</b>						
10.4 mm	12 AWG/2.5 mm <sup>2</sup>	400/—/24–12	300/10/28–12	Gray	50	<b>XBTKT25 (Type T)</b>
<b>Iron/Constantan (FE/CUNI44)</b>						
10.4 mm	12 AWG/2.5 mm <sup>2</sup>	400/—/24–12	300/10/28–12	Gray	50	<b>XBTKJ25 (Type J)</b>
<b>Nickel-Chrome/Constantan (NICR/CUNI44)</b>						
10.4 mm	12 AWG/2.5 mm <sup>2</sup>	400/—/24–12	300/10/28–12	Gray	50	<b>XBTKE25 (Type E)</b>
<b>Nickel-Chrome/Nickel (NICRNI)</b>						
10.4 mm	12 AWG/2.5 mm <sup>2</sup>	400/—/24–12	300/10/28–12	Gray	50	<b>XBTKK25 (Type K)</b>
<b>Copper/Copper Nickel (E-CU/A-CU)</b>						
10.4 mm	12 AWG/2.5 mm <sup>2</sup>	400/—/24–12	300/10/28–12	Gray	50	<b>XBTKR25 (Type R)</b>

## Accessories

## Screw Connection Disconnect and Component Terminal Blocks

Description	Color	Number of Positions	Standard Pack	XBUT4TG	XBUT4MT	XBUKK4D10	XBTK25
				Catalog Number	Catalog Number	Catalog Number	Catalog Number
Plug-in bridge—for cross connections in the bridge shaft	Red	2	10	XBAFBS26	XBAFBS26	—	—
		3	10	XBAFBS36	XBAFBS36	—	—
		5	10	XBAFBS56	XBAFBS56	—	—
		10	10	XBAFBS106	XBAFBS106	—	—
		50	10	XBAFBS506	XBAFBS506	—	—
Test adapter	—	—	10	XBATSPA14	XBATSPA14	—	—
2.3 mm diameter test plug	—	—	—	XBATSMPS- <sup>①</sup>	XBATSMPS- <sup>①</sup>	—	—
Modular test plug	—	—	10	XBATSDPPS6	XBATSDPPS6	—	—
Blank marker strip (strip of 10)	White	—	10	XBMZB6 <sup>②</sup>	XBMZB6 <sup>②</sup>	XBMZB6 <sup>②</sup>	XBMZB10 <sup>②</sup>
End cover	Gray	—	10	—	—	XBACUKK35	XBACTK4
Spacer cover	Gray	—	10	—	—	XBADGUKK35	—
Spacer plate	—	—	10	—	—	XBADPUKK35	—
Partition plate	—	—	—	—	—	—	XBATTK4
Fixed bridge	—	10	10	—	—	XBAFBI106	—

## Technical Data and Specifications

## Screw Connection Disconnect and Component Terminal Blocks

Description	XBUT4TG	XBUT4MT	XBUKK4D10	XBTK
<b>Technical Data in Accordance with IEC</b>				
Maximum load current in A/cross-section in mm <sup>2</sup>	16/6	16/6	32/4	—
Rated surge voltage in kV/contamination class	6/3	6/3	6/3	—
Surge voltage category/insulating material group	III/I	III/I	III/I	—
<b>Connection Capacity</b>				
Stranded with ferrule/with ferrule and plastic sleeve in mm <sup>2</sup>	0.25–4/0.25–4	0.25–4/0.25–4	0.25–4/0.25–2.5	—
<b>Multi-Conductor Connection</b> (same cross-section)				
Solid/stranded in mm <sup>2</sup>	0.14–1.5/0.14–1.5	0.14–1.5/0.14–1.5	0.2–1.5/0.2–1.5	—
Stranded with ferrules without plastic sleeve in mm <sup>2</sup>	0.25–1.5	0.25–1.5	0.25–1.5	—
Stranded with twin ferrule with plastic sleeve in mm <sup>2</sup>	0.5–2.5	0.5–2.5	0.5–1.5	—
Stripping length in inches (mm)	0.35 (9)	0.35 (9)	0.31 (8)	0.28 (7)
Thread	M3	M3	M3	M3
Torque in in-lb (Nm)	5.3–7.1 (0.6–0.8)	5.3–7.1 (0.6–0.8)	5.3–7.1 (0.6–0.8)	5.3–7.1 (0.6–0.8)

## Dimensions

Approximate Dimensions in Inches (mm)

## Screw Connection Disconnect and Component Terminal Blocks

Catalog Number	Width	Length	Cover Width	Height for—		
				35 x 7.5 in	35 x 15 in	32 in
XBUT4TG	0.24 (6.2)	2.24 (56.8)	—	1.87 (47.5)	2.17 (55.0)	—
XBUT4MT	0.24 (6.2)	2.24 (56.8)	—	1.87 (47.5)	2.17 (55.0)	—
XBUKK4D10	0.24 (6.2)	2.20 (56.0)	0.10 (2.5)	2.44 (62.0)	2.74 (69.5)	2.64 (67.0)
XBTK	0.20 (5.2)	1.81 (46.0)	0.04 (1.0)	1.57 (40.0)	1.87 (47.5)	1.77 (45.0)

## Notes

① For ordering information, see Page V7-T42-105.

② For information on Printed Marking Tag Options, see Page V7-T42-98.

For additional accessories, see Page V7-T42-90.

**High Current Blocks**

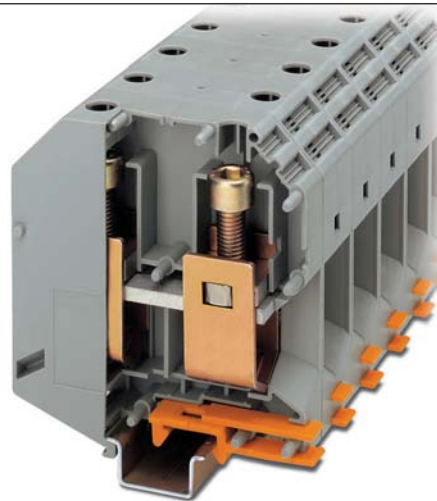

**Contents**

<b>Description</b>	<b>Page</b>
Single Level—Through-Feed	V7-T42-5
Single Level—Ground Blocks	V7-T42-10
Multi-Conductor Terminal Blocks	V7-T42-12
Multi-Conductor Ground Blocks	V7-T42-14
Double Level	V7-T42-16
Triple Level Sensor/Actuator	V7-T42-18
Fuse Terminal Blocks	V7-T42-21
Disconnect and Component Terminal Blocks	V7-T42-24
High Current Blocks	
Accessories	V7-T42-28
Technical Data and Specifications	V7-T42-28
Dimensions	V7-T42-28
Mini Screw Connection	V7-T42-29

**High Current Blocks**

**Product Description**

Eaton's XBUK high current terminal blocks offer a reliable connection via the superior construction that includes three-point centering of the wire in the

prism-shaped sleeve base, a fluted contact surface for low contact resistance, and screws secured with spring-loaded elements. The terminal blocks have

an enclosed housing made from polyamide 6.6. Green-yellow ground terminal blocks are also available.

**Product Selection**

**XBUK150**



**Screw Connection High Current Blocks**

Terminal Width	Maximum Wire Size	IEC 60 947-7-1 in V/A/AWG	EN 50 019 ① in V/A/AWG	UL-cUL Ratings in V/A/AWG	Color	Standard Pack	Catalog Number
20.0 mm	1/0/50 mm <sup>2</sup>	1000/150/1/0	750/135/1/0	600/150/1/0	Gray	10	XBUK50
					Blue	10	XBUK50BU
31.0 mm	300 kcmil/150 mm <sup>2</sup>	1000/309/2-300	726/265/2-300	600/285/2 AWG-300 kcmil	Gray	10	XBUK150

**XBUK95PE**



**Screw Connection High Current Ground Blocks**

Terminal Width	Maximum Wire Size	IEC 60 947-7-1 in V/A/AWG	EN 50 019 ① in V/A/AWG	UL-cUL Ratings in V/A/AWG	Color	Standard Pack	Catalog Number
25.0 mm	000 AWG/95 mm <sup>2</sup>	—/232/4-000	—/—/4-000	—/—/2-4/0	Green/Yellow	10	XBUK95PE

**Note**

① U type—examination certificate number: KEMA 05ATEX2170 U (XBUK50), KEMA 05ATEX2171 U (XBUK150).

## Accessories

## Screw Connection High Current Blocks

Description	Color	Number of Positions	Standard Pack	XBUK50 Catalog Number	XBUK150 Catalog Number	XBUK95PE Catalog Number
Fixed bridge, screw heads with insulating color	—	2	10	XBAFBI220	—	—
Insertion bridge	—	2	10	—	XBAEB231	—
Blank marker strip external labeling (strip of 10)	White	—	10	XBMZB10 ①	XBMZB10 ①	XBMZB10 ①

## Technical Data and Specifications

## Screw Connection High Current Blocks

Description	XBUK50	XBUK150	XBUK95PE
<b>Technical Data in Accordance with IEC</b>			
Maximum load current in A/cross-section in mm <sup>2</sup>	150/50	309/150	232/95
Maximum cross-section with insertion bridge solid/stranded in mm <sup>2</sup>	—/—	150/120	—/—
Rated surge voltage in kV/contamination class	8/3	8/3	8/3
Surge voltage category/insulating material group	III/I	III/I	III/I
<b>Connection Capacity</b>			
Stranded with ferrule/with ferrule and plastic sleeve in mm <sup>2</sup>	25–50/25–50	50–150/50–150	35–95/35–95
<b>Multi-Conductor Connection</b> (same cross-section)			
Solid/stranded in mm <sup>2</sup>	10–16/10–16	25–50/35–50	25–35/25–35
Stranded with ferrules without plastic sleeve in mm <sup>2</sup>	10–16	25–50	16–35
Stripping length in inches (mm)	0.94 (24)	1.57 (40)	1.18 (30)
Thread	M6	M10	M8
Terminal point—thread/torque in in-lb (Nm)	53–71 (6–8)	221–267 (25–30)	133–177 (15–20)
Fastening—thread/torque in in-lb (Nm)	53–71 (6–8)	221–267 (25–30)	133–177 (15–20)

## Dimensions

Approximate Dimensions in Inches (mm)

## Screw Connection High Current Blocks

Catalog Number	Width	Length	Height for—		
			35 x 7.5 in	35 x 15 in	32 in
XBUK50	0.79 (20.0)	2.78 (70.5)	3.29 (83.5)	3.21 (81.5)	—
XBUK150	1.22 (31.0)	3.94 (100.0)	4.67 (118.5)	4.57 (116.0)	—
XBUK95PE	0.98 (25.0)	3.27 (83.0)	—	3.90 (99.0)	3.80 (96.5)

## Notes

① For information on Printed Marking Tag Options, see Page V7-T42-98.

For additional accessories, see Page V7-T42-90.

## Mini Screw Connection Terminal Blocks



## Contents

<b>Description</b>	<b>Page</b>
Single Level—Through-Feed	V7-T42-5
Single Level—Ground Blocks	V7-T42-10
Multi-Conductor Terminal Blocks	V7-T42-12
Multi-Conductor Ground Blocks	V7-T42-14
Double Level	V7-T42-16
Triple Level Sensor/Actuator	V7-T42-18
Fuse Terminal Blocks	V7-T42-21
Disconnect and Component Terminal Blocks	V7-T42-24
High Current Blocks	V7-T42-27
Mini Screw Connection	
Accessories	V7-T42-30
Technical Data and Specifications	V7-T42-30
Dimensions	V7-T42-30

## Mini Screw Connection

## Product Description

The **XB** miniature terminal blocks have a connection cross-section from 2 mm<sup>2</sup> through 4 mm<sup>2</sup> and mount on 15 mm DIN rail. There is an

opening for bridging with a fixed bridge in the center of the terminal blocks. These miniature terminal blocks also offer the same accessories

that you would find with the larger blocks—including marking tags, end covers, end stop and ground blocks.

## Product Selection

## XBMUK4



## Mini Screw Connection Terminal Blocks

Terminal Width	Maximum Wire Size	IEC 60 947-7-1 in V/A/AWG	EN 50 019 ① in V/A/AWG	UL-cUL Ratings in V/A/AWG	Color	Standard Pack	Catalog Number
5.2 mm	12 AWG/2.5 mm <sup>2</sup>	400/32/24–12	275/28/21/24–12	600/20/28–12	Gray	50	XBMUK25
					Blue	50	XBMUK25BU
6.2 mm	10 AWG/4 mm <sup>2</sup>	500/41/24–10	—/—/—	600/10/26–10	Gray	50	XBMUK4
					Blue	50	XBMUK4BU

## XBMUK25PE



## Mini Screw Connection Ground Blocks

Terminal Width	Maximum Wire Size	IEC 60 947-7-2 in V/A/AWG	UL-cUL Ratings in V/A/AWG	Color	Standard Pack	Catalog Number
5.2 mm	12 AWG/2.5 mm <sup>2</sup>	—/—/24–12	—/—/30–12	Green/ Yellow	50	XBMUK25PE
6.2 mm	10 AWG/2.4 mm <sup>2</sup>	—/—/24–10	—/—/26–14	Green/ Yellow	50	XBMUK4PE

## Note

① EU type—examination certificate number: KEMA 05ATEX2169 U (XBMUK25).

## Accessories

## Mini Screw Connection Terminal/Ground Blocks

Description	Color	Number of Positions	Standard Pack	XBMUK25 Catalog Number	XBMUK4 Catalog Number	XBMUK25PE Catalog Number	XBMUK4PE Catalog Number
End cover	Gray	—	10	<b>XBACMU254</b>	<b>XBACMU254</b>	—	—
	Blue	—	10	<b>XBACMU254B</b>	<b>XBACMU254B</b>	—	—
Partition plate	—	—	10	<b>XBATMU254</b>	<b>XBATMU254</b>	—	—
Fixed bridge	—	10	10	<b>XBAFBR105N</b>	—	—	—
Separating plate	—	—	10	<b>XBATMPKK15</b>	<b>XBATMPKK15</b>	—	—
Blank marker strip (strip of 10)	White	—	10	<b>XBMZB5</b> ①	<b>XBMZB6</b> ①	<b>XBMZB5</b> ①	<b>XBMZB6</b> ①

## Technical Data and Specifications

## Mini Spring Cage Terminal/Ground Blocks

Description	XBMUK25	XBMUK4	XBMUK25PE	XBMUK4PE
<b>Technical Data in Accordance with IEC</b>				
Maximum load current in A/cross-section in mm <sup>2</sup>	32/4	41/6	—	—
Maximum cross-section with insertion bridge (solid/stranded)	2.5/2.5	4/4	—	—
Rated surge voltage in kV/contamination class	6/3	6/3	6/3	6/3
Surge voltage category/insulating material group	III/I	III/I	III/I	III/I
<b>Connection Cross-Section</b>				
Stranded with ferrule with plastic sleeve in mm <sup>2</sup>	0.25–1.5	0.25–2.5	0.25–1.5	0.25–2.5
Stranded with ferrule without plastic sleeve in mm <sup>2</sup>	0.25–2.5	0.25–4	0.25–2.5	0.25–4
<b>Multi-Conductor Connection</b> (same cross-section)				
Solid/stranded in mm <sup>2</sup>	0.2–1.0/0.2–1.5	0.2–1.5/0.2–1.5	0.2–1.0/0.2–1.5	0.2–1.5/0.2–1.5
Stranded with ferrule without plastic sleeve in mm <sup>2</sup>	0.25–1.5	0.25–1.5	0.25–1.5	0.25–1.5
Stranded with ferrule with plastic sleeve in mm <sup>2</sup>	0.5–1.0	0.5–2.5	0.5–1.5	0.5–2.5
Stripping length in Inches (mm)	0.31 (8)	0.31 (8)	0.31 (8)	0.31 (8)
Thread	M3	M3	M3	M3
Torque in in-lb (Nm)	5.3–7.1 (0.6–0.8)	4.4–5.3 (0.5–0.6)	5.3–7.1 (0.6–0.8)	5.3–7.1 (0.6–0.8)

## Dimensions

Approximate Dimensions in Inches (mm)

## Mini Spring Cage Terminal/Ground Blocks

Catalog Number	Width	Length	Cover Length	Height for— 15 in
<b>XBMUK25</b>	0.20 (5.2)	1.10 (28.0)	0.04 (1.0)	1.26 (32.0)
<b>XBMUK4</b>	0.24 (6.2)	1.10 (28.0)	0.04 (1.0)	1.26 (32.0)
<b>XBMUK25PE</b>	0.20 (5.2)	1.10 (28.0)	—	1.24 (31.5)
<b>XBMUK4PE</b>	0.24 (6.2)	1.10 (28.0)	—	1.26 (32.0)

## Notes

① For information on Printed Marking Tag Options, see [Page V7-T42-98](#).For additional accessories, see [Page V7-T42-90](#).

Spring Cage Connection



## Contents

### Description

Description	Page
Spring Cage Terminal Blocks	
Single Level—Through-Feed	V7-T42-32
Single Level—Ground Blocks	V7-T42-37
Multi-Conductor Terminal Blocks	V7-T42-39
Multi-Conductor Ground Blocks	V7-T42-42
Double Level Blocks	V7-T42-44
Triple Level Blocks	V7-T42-46
Fuse Terminal Blocks	V7-T42-48
Disconnect and Component Terminal Blocks	V7-T42-51
Hybrid Terminal Blocks	V7-T42-54
Mini Spring Cage	V7-T42-56



Drawings  
Online

## Spring Cage Terminal Blocks Overview

### Product Description

The XBPT Series incorporates a spring cage connection system proven in applications that are sensitive to vibration. The spring mechanism always exerts the same constant force on the wire, resulting in a vibration-proof, gas-tight connection, independent of the user. The space-saving front connection, with the wire and screwdriver coming in parallel from the same direction, allows for simple wiring in places where there is little space available.

### Application Description

The connection point is opened with a standard screwdriver. After the wire has been inserted into the wire guide of the terminal block, the screwdriver is removed and the wire automatically makes contact.

### Features

- Vibration-resistance
- Global acceptance
- Multi-conductor connections
- Flexible Plug-in bridge system
- Large surface area for marking
- Standardized testing system

### Standards and Certifications

- UL recognized—File No. E67464
- CE approved
- LVD ①:
  - EN 60947-7-1
  - EN 60947-7-2
  - EN 60998-2-3
  - EN 60352-4/A1
- ATEX approval (Eex e applications)



#### Note

- ① Not all standards apply to all terminal blocks. Contact Eaton for details.

# 42.1

## Terminal Blocks, Fuse Blocks and Fuse Holders

IEC—XB Series

Single Level—Through-Feed



42

### Contents

#### Description

#### Page

Single Level—Through-Feed	
Accessories	V7-T42-34
Technical Data and Specifications	V7-T42-36
Dimensions	V7-T42-36
Single Level—Ground Blocks	V7-T42-37
Multi-Conductor Terminal Blocks	V7-T42-39
Multi-Conductor Ground Blocks	V7-T42-42
Double Level Blocks	V7-T42-44
Triple Level Blocks	V7-T42-46
Fuse Terminal Blocks	V7-T42-48
Disconnect and Component Terminal Blocks	V7-T42-51
Hybrid Terminal Blocks	V7-T42-54
Mini Spring Cage	V7-T42-56

### Single Level—Through-Feed

#### Product Description

The space-saving design and front entry design make the XBPT Series ideal for control systems where there is little space. Even so, they offer maximum connection space, resulting in fast wiring of stranded and solid conductors with or without ferrules.

XBPT terminal blocks are available with cross-sections from 2.5 mm<sup>2</sup> up to 35 mm<sup>2</sup>. The double bridge shaft can accommodate individual chain bridging and step-down bridging from other terminal blocks.



## Product Selection

XBPT6



## Spring Cage Connection Single Level—Through-Feed

Terminal Width	Maximum Wire Size	IEC 60 947-7-1 in V/A/AWG	EN 50 019 <sup>①</sup> in V/A/AWG	UL-cUL Ratings in V/A/AWG	Color	Standard Pack	Catalog Number
5.2 mm	12 AWG/2.5 mm <sup>2</sup>	800/31/28–12	550/25/21/24–12	600/20/26–12	Gray	50	<b>XBPT25</b>
					Blue	50	<b>XBPT25BU</b>
					White	50	<b>XBPT25WH</b>
					Red	50	<b>XBPT25RD</b>
					Black	50	<b>XBPT25BK</b>
6.2 mm	10 AWG/4 mm <sup>2</sup>	800/40/28–10	550/34/30/24–10	600/30/20–10	Gray	50	<b>XBPT4</b>
					Blue	50	<b>XBPT4BU</b>
8.2 mm	8 AWG/6 mm <sup>2</sup>	800/52/24–8	550/45/36/20–8	600/50/20–8	Gray	50	<b>XBPT6</b>
					Blue	50	<b>XBPT6BU</b>
10.2 mm	6 AWG/10 mm <sup>2</sup>	800/65/24–6	550/50/63/16–6	600/65/16–6	Gray	50	<b>XBPT10</b>
					Blue	50	<b>XBPT10BU</b>
12 mm	4 AWG/16 mm <sup>2</sup>	800/90/24–4	550/65/82/16–4	600/50/16–4	Gray	50	<b>XBPT16</b>
					Blue	50	<b>XBPT16BU</b>
16 mm	2 AWG/35 mm <sup>2</sup>	800/125/14–2	750/108/14–2	600/115/14–2	Gray	50	<b>XBPT35</b>
					Blue	50	<b>XBPT35BU</b>

**Note**

<sup>①</sup> EU type—examination certificate number: KEMA 05ATEX2158 U.

#### Accessories

##### Spring Cage Connection Single Level—Through-Feed, XBPT25, XBPT4 and XBPT6

Description	Color	Number of Positions	Standard Pack	XBPT25 Catalog Number	XBPT4 Catalog Number	XBPT6 Catalog Number
End cover	Gray	—	10	<b>XBACPT25</b>	<b>XBACPT4</b>	<b>XBACPT6</b>
Partition plate	Gray	—	10	<b>XBATPT4</b>	<b>XBATPT4</b>	<b>XBATPT6</b>
Plug-in bridge—for cross connections in the bridge shaft	Red	2	10	<b>XBAFBS25</b>	<b>XBAFBS26</b>	<b>XBAFBS28</b>
		3	10	<b>XBAFBS35</b>	<b>XBAFBS36</b>	—
		5	10	<b>XBAFBS55</b>	<b>XBAFBS56</b>	—
		10	10	<b>XBAFBS105</b>	<b>XBAFBS106</b>	—
		50	10	<b>XBAFBS505</b>	<b>XBAFBS506</b>	—
Test adapter	—	—	10	<b>XBATSPA14</b>	<b>XBATSPA14</b>	<b>XBATSPA14</b>
2.3 mm diameter test plug	—	—	—	<b>XBATSMPS-<sup>①</sup></b>	<b>XBATSMPS-<sup>①</sup></b>	<b>XBATSMPS-<sup>①</sup></b>
Modular test plug	—	—	10	<b>XBATSPS5</b>	<b>XBATSPS6</b>	<b>XBATSPS8</b>
Blank marker strip external labeling	White	—	10	<b>XBMZBF5<sup>②</sup></b>	<b>XBMZBF6<sup>②</sup></b>	<b>XBMZBF8<sup>②</sup></b>
Blank marker strip center labeling (strip of 10)	White	—	10	<b>XBMZB5<sup>②</sup></b>	<b>XBMZB6<sup>②</sup></b>	<b>XBMZB8<sup>②</sup></b>

##### Spring Cage Connection Single Level—Through-Feed, XBPT10, XBPT16 and XBPT35

Description	Color	Number of Positions	Standard Pack	XBPT10 Catalog Number	XBPT16 Catalog Number	XBPT35 Catalog Number
End cover	Gray	—	10	<b>XBACPT10</b>	<b>XBACPT16</b>	<sup>③</sup>
Plug-in bridge—for cross connections in the bridge shaft	Red	2	10	<b>XBAFBS210</b>	<b>XBAFBS212<sup>①</sup></b>	<b>XBAFBS216<sup>②</sup></b>
2.3 mm diameter test plug	—	—	10	<b>XBATSMPS-<sup>①</sup></b>	<b>XBATSMPS-<sup>①</sup></b>	<b>XBATSMPS-<sup>①</sup></b>
Blank marker strip external labeling	White	—	10	<b>XBMZF10<sup>②</sup></b>	<b>XBMZBF12<sup>②</sup></b>	<b>XBMZBF15<sup>②</sup></b>
Blank marker strip center labeling (strip of 10)	White	—	10	<b>XBMZB10<sup>②</sup></b>	<b>XBMZB12<sup>②</sup></b>	<b>XBMZB15<sup>②</sup></b>

#### Notes

- ① For ordering information, see **Page V7-T42-105**.
- ② For information on Printed Marking Tag Options, see **Page V7-T42-98**.
- ③ XBPT35 has an enclosed design. The use of an end cover is not required.

For additional accessories, see **Page V7-T42-90**.

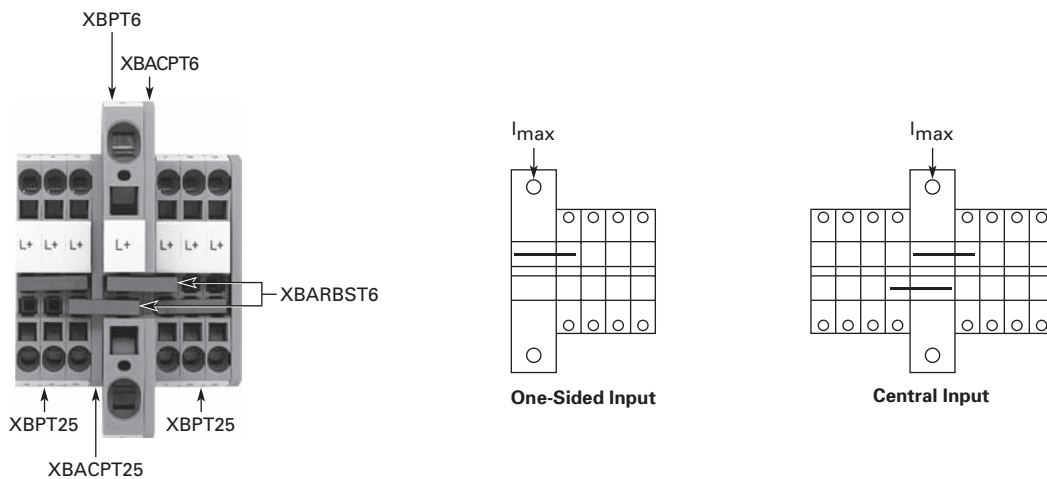
**XBPT with Reducing Bridge****Step-Down Bridge with Standard Feed-Through Terminal Blocks**

Input Terminal Blocks	Cross-Section	Pick-Off Terminal Blocks	Cross-Section AWG (mm <sup>2</sup> )	One-Sided Input $I_{max}$	Central Input $I_{max}$	Bridge Catalog Number
XBPT6	8 AWG (6 mm <sup>2</sup> )	XBPT25	12 (2.5)	40	56	<b>XBARBST6</b>
		XBPT4	10 (4)	45	56	<b>XBARBST6</b>
		XBQT15	14 (1.5)	35	56	<b>XBARBST6</b>
		XBQT25	12 (2.5)	40	56	<b>XBARBST6</b>
XBPT10	6 AWG (10 mm <sup>2</sup> )	XBPT25	12 (2.5)	40	65	<b>XBARBST10</b>
		XBPT4	10 (4)	45	65	<b>XBARBST10</b>
		XBQT15	14 (1.5)	35	65	<b>XBARBST10</b>
		XBQT25	12 (2.5)	40	65	<b>XBARBST10</b>
XBPT16	4 AWG (16 mm <sup>2</sup> )	XBPT25	12 (2.5)	40	80	<b>XBARBST16</b>
		XBPT4	10 (4)	45	90	<b>XBARBST16</b>
		XBQT15	14 (1.5)	35	70	<b>XBARBST16</b>
		XBQT25	12 (2.5)	40	80	<b>XBARBST16</b>

## Technical Data and Specifications

### Spring Cage Connection Single Level—Through-Feed

Description	XBPT25	XBPT4	XBPT6	XBPT10	XBPT16	XBPT35
<b>Technical Data in Accordance with IEC</b>						
Maximum load current in A/cross-section in mm <sup>2</sup>	31/4	40/6	52/10	65/16	90/25	125/35
Rated surge voltage in kV/contamination class	8/3	8/3	8/3	8/3	8/3	8/3
Surge voltage category/insulating material group	III/I	III/I	III/I	III/I	III/I	III/I
<b>Connection Capacity</b>						
Stranded with ferrule/with ferrule and plastic sleeve in mm <sup>2</sup>	0.25–2.5	0.25–4	0.25–6	0.25–10	0.25–16	2.5–35
Stranded with ferrules without plastic sleeve in mm <sup>2</sup>	0.25–2.5	0.25–4	0.25–6	0.25–10	0.25–16	2.5–35
Stranded with twin ferrule with plastic sleeve in mm <sup>2</sup>	0.5	0.5–1	0.5–1.5	1.5–2.5	1.5–4	2.5–10
Stripping length in inches (mm)	0.39 (10)	0.39 (10)	0.47 (12)	0.71 (18)	0.71 (18)	0.98 (25)

## Dimensions

Approximate Dimensions in Inches (mm)

### Spring Cage Connection Single Level—Through-Feed

Catalog Number	Width	Length	Cover Width	Height for—	
				35 x 7.5 in	35 x 15 in
XBPT25	0.20 (5.2)	1.91 (48.5)	0.09 (2.2)	1.45 (36.8)	1.73 (44.0)
XBPT4	0.24 (6.2)	2.20 (56.0)	0.09 (2.2)	1.45 (36.8)	1.73 (44.0)
XBPT6	0.32 (8.2)	2.74 (69.5)	0.09 (2.2)	1.71 (43.5)	2.01 (51.0)
XBPT10	0.39 (10.0)	2.81 (71.5)	0.09 (2.2)	1.99 (50.5)	2.30 (58.5)
XBPT16	0.47 (12.0)	3.15 (80.0)	0.09 (2.2)	2.01 (51.0)	2.30 (58.5)
XBPT35	0.63 (16.0)	3.94 (100.0)	①	2.32 (59.0)	2.62 (66.5)

#### Note

① XBPT35 has an enclosed design. The use of an end cover is not required.

## Single Level—Ground Blocks



## Contents

<b>Description</b>	<b>Page</b>
Single Level—Through-Feed .....	<b>V7-T42-32</b>
Single Level—Ground Blocks	
Accessories .....	<b>V7-T42-38</b>
Technical Data and Specifications .....	<b>V7-T42-38</b>
Dimensions .....	<b>V7-T42-38</b>
Multi-Conductor Terminal Blocks .....	<b>V7-T42-39</b>
Multi-Conductor Ground Blocks .....	<b>V7-T42-42</b>
Double Level Blocks .....	<b>V7-T42-44</b>
Triple Level Blocks .....	<b>V7-T42-46</b>
Fuse Terminal Blocks .....	<b>V7-T42-48</b>
Disconnect and Component Terminal Blocks .....	<b>V7-T42-51</b>
Hybrid Terminal Blocks .....	<b>V7-T42-54</b>
Mini Spring Cage .....	<b>V7-T42-56</b>

## Single Level—Ground Blocks

## Product Description

The XBPT ground blocks are the same shape as the feed-through terminal blocks with the same wide range of cross-sections available. They easily snap onto the

DIN rail to make a reliable mechanical and electrical contact that meets all requirements of IEC 60-947-7-2.

## Product Selection

## XBPT4PE



## Spring Cage Connection Single Level—Ground Blocks

Terminal Width	Maximum Wire Size	IEC 60 947-7-2 in V/A/AWG	EN 50 019 ① in V/A/AWG	UL-cUL Ratings in V/A/AWG	Color	Standard Pack	Catalog Number
5.2 mm	12 AWG/2.5 mm <sup>2</sup>	—/—/28-12	—/—/24-12	—/—/26-12	Green/Yellow	50	<b>XBPT25PE</b>
6.2 mm	10 AWG/4 mm <sup>2</sup>	—/—/28-10	—/—/24-10	—/—/20-10	Green/Yellow	50	<b>XBPT4PE</b>
8.2 mm	8 AWG/6 mm <sup>2</sup>	—/—/24-8	—/—/20-8	—/—/20-8	Green/Yellow	50	<b>XBPT6PE</b>
10.2 mm	6 AWG/10 mm <sup>2</sup>	—/65/24-6	—/—/16-6	—/—/16-6	Green/Yellow	50	<b>XBPT10PE</b>
12 mm	4 AWG/16 mm <sup>2</sup>	—/90/24-4	—/—/16-4 ②	—/—/16-4	Green/Yellow	25	<b>XBPT16PE</b>
16 mm	2 AWG/35 mm <sup>2</sup>	—/125/14-2	—/—/14-2 ②	—/—/14-2	Green/Yellow	10	<b>XBPT35PE</b>

## Notes

① EU type—examination certificate number: KEMA 05ATEX2154 U (XBPT25PE), KEMA 05ATEX2155 U (XBPT4PE).

② EU type—examination certificate number: KEMA 05ATEX2156 U.

## Accessories

## Spring Cage Connection Single Level Ground Blocks, XBPT25PE, XBPT4PE and XBPT6PE

Description	Color	Number of Positions	Standard Pack	XBPT25PE Catalog Number	XBPT4PE Catalog Number	XBPT6PE Catalog Number
End cover	Gray	—	10	<b>XBACPT25</b>	<b>XBACPT4</b>	<b>XBACPT6</b>
Blank marker strip external labeling	White	—	10	<b>XBMZBF5</b> ①	<b>XBMZBF6</b> ①	<b>XBMZBF8</b> ①
Blank marker strip center labeling (strip of 10)	White	—	10	<b>XBMZB5</b> ①	<b>XBMZB6</b> ①	<b>XBMZB8</b> ①

## Spring Cage Connection Single Level Ground Blocks, XBPT10PE, XBPT16PE and XBPT35PE

Description	Color	Number of Positions	Standard Pack	XBPT10PE Catalog Number	XBPT16PE Catalog Number	XBPT35PE Catalog Number
End cover	Gray	—	10	<b>XBACPT10</b>	<b>XBACPT16</b>	②
Plug-in bridge—for cross connections in the bridge shaft	—	2	10	<b>XBAFBS210</b>	<b>XBAFBS212</b>	<b>XBAFBS216</b>
Blank marker strip external labeling	White	—	10	<b>XBMZBF10</b> ①	<b>XBMZBF12</b> ①	<b>XBMZBF15</b> ①
Blank marker strip center labeling (strip of 10)	White	—	10	<b>XBMZB10</b> ①	<b>XBMZB12</b> ①	<b>XBMZB15</b> ①

## Technical Data and Specifications

## Spring Cage Connection Single Level Ground Blocks

Description	XBPT25PE	XBPT4PE	XBPT6PE	XBPT10PE	XBPT16PE	XBPT35PE
<b>Technical Data in Accordance with IEC</b>						
Maximum load current in A/cross-section in mm <sup>2</sup>	—	—	—	65/16	90/25	125/35
Rated surge voltage in kV/contamination class	8/3	8/3	8/3	8/3	8/3	8/3
Surge voltage category/insulating material group	III/I	III/I	III/I	III/I	III/I	III/I
<b>Connection Capacity</b>						
Stranded with ferrule with plastic sleeve in mm <sup>2</sup>	0.25–2.5	0.25–4	0.25–6	0.25–10	0.25–16	2.5–35
Stranded with ferrules without plastic sleeve in mm <sup>2</sup>	0.25–2.5	0.25–4	0.25–6	0.25–10	0.25–16	2.5–35
Stranded with twin ferrule with plastic sleeve in mm <sup>2</sup>	0.5	0.5–1	0.5–1.5	1.5–2.5	1.5–4	2.5–10
Stripping length in inches (mm)	0.39 (10)	0.39 (10)	0.47 (12)	0.71 (18)	0.71 (18)	0.98 (25)

## Dimensions

Approximate Dimensions in Inches (mm)

## Spring Cage Connection Single Level Ground Blocks

Catalog Number	Width	Length	Cover Width	Height for—	
				35 x 7.5 in	35 x 15 in
<b>XBPT25PE</b>	0.20 (5.2)	1.91 (48.5)	0.09 (2.2)	1.45 (36.8)	1.73 (44.0)
<b>XBPT4PE</b>	0.24 (6.2)	2.20 (56.0)	0.09 (2.2)	1.45 (36.8)	1.73 (44.0)
<b>XBPT6PE</b>	0.32 (8.2)	2.74 (69.5)	0.09 (2.2)	1.71 (43.5)	2.01 (51.0)
<b>XBPT10PE</b>	0.39 (10.0)	2.81 (71.5)	0.09 (2.2)	1.99 (50.5)	2.28 (58.0)
<b>XBPT16PE</b>	0.47 (12.0)	3.15 (80.0)	0.09 (2.2)	2.01 (51.0)	2.30 (58.5)
<b>XBPT35PE</b>	0.63 (16.0)	3.94 (100.0)	—	2.32 (59.0)	2.62 (66.5)

## Notes

① For information on Printed Marking Tag Options, see **Page V7-T42-98**.

② XBPT35PE has an enclosed design. The use of an end cover is not required.

For additional accessories, see **Page V7-T42-90**.

## Multi-Conductor Terminal Blocks

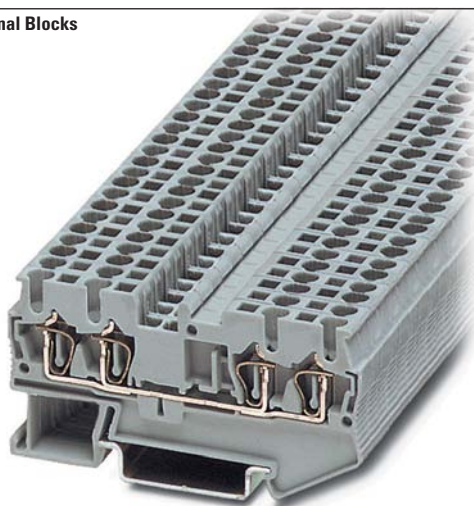

## Contents

<b>Description</b>	<b>Page</b>
Single Level—Through-Feed .....	<b>V7-T42-32</b>
Single Level—Ground Blocks .....	<b>V7-T42-37</b>
Multi-Conductor Terminal Blocks	
Accessories .....	<b>V7-T42-40</b>
Technical Data and Specifications .....	<b>V7-T42-41</b>
Dimensions .....	<b>V7-T42-41</b>
Multi-Conductor Ground Blocks .....	<b>V7-T42-42</b>
Double Level Blocks .....	<b>V7-T42-44</b>
Triple Level Blocks .....	<b>V7-T42-46</b>
Fuse Terminal Blocks .....	<b>V7-T42-48</b>
Disconnect and Component Terminal Blocks .....	<b>V7-T42-51</b>
Hybrid Terminal Blocks .....	<b>V7-T42-54</b>
Mini Spring Cage .....	<b>V7-T42-56</b>

## Multi-Conductor Terminal Blocks

## Product Description

The multi-conductor terminal blocks offer a space-saving alternative to standard feed-through terminal blocks, allowing for high-density wiring. Often, three connections have to be led to one terminal block. The XBPT...D12 terminal block accomplishes this without

any additional terminal blocks or bridging required. The XBPT...D22 terminal blocks allow four wires to be connected to one potential—and can therefore be used as compact power distributors. There is also a version, XBPT25D22U or XBPT4D22U, with an interrupted bus bar in

the terminal center. This makes two feed-through terminal blocks available in one level. One side of this block can be bridged using the standard Plug-in bridges. Double marker carriers are available for clear marking of the feed-through levels.

## Product Selection

## XBPT4D12



## Spring Cage Connection Multi-Conductor Terminal Blocks, Three-Wire

Terminal Width	Maximum Wire Size	IEC 60 947-7-1 in V/A/AWG	EN 50 019 ① in V/A/AWG	UL-cUL Ratings in V/A/AWG	Color	Standard Pack	Catalog Number
5.2 mm	12 AWG/2.5 mm <sup>2</sup>	800/28/28–12	550/25/21/24–12	600/20/26–12	Gray	50	<b>XBPT25D12</b>
					Blue	50	<b>XBPT25D12BU</b>
6.2 mm	10 AWG/4 mm <sup>2</sup>	800/40/28–10	550/34/29/24–10	600/30/20–10	Gray	50	<b>XBPT4D12</b>
					Blue	50	<b>XBPT4D12BU</b>

## Note

① EU type—examination certificate number: KEMA 05ATEX2154 U (XBPT25D12), KEMA 05ATEX2155 U (XBPT4D12).

XBPT25D22



#### Spring Cage Connection Multi-Conductor Terminal Blocks, Four-Wire

Terminal Width	Maximum Wire Size	IEC 60 947-7-1 in V/A/AWG	EN 50 019 ① in V/A/AWG	UL-cUL Ratings in V/A/AWG	Color	Standard Pack	Catalog Number
<b>Spring Cage Multi-Conductor</b>							
5.2 mm	12 AWG/2.5 mm <sup>2</sup>	800/28/28-12	550/24/21/24-12	600/20/26-12	Gray	50	<b>XBPT25D22</b>
					Blue	50	<b>XBPT25D22BU</b>
6.2 mm	10 AWG/4 mm <sup>2</sup>	800/40/28-10	550/34/25/24-10	600/30/20-10	Gray	50	<b>XBPT4D22</b>
					Blue	50	<b>XBPT4D22BU</b>
<b>Spring Cage Multi-Conductor with Interrupted Bus Bar</b>							
5.2 mm	12 AWG/2.5 mm <sup>2</sup>	800/28/28-12	550/24/21/24-12	600/20/26-12	Blue	50	<b>XBPT25D22U</b>
6.2 mm	10 AWG/4 mm <sup>2</sup>	800/40/28-10	550/34/25/24-10	600/30/20-10	Blue	50	<b>XBPT4D22U</b>

### Accessories

#### Spring Cage Connection Multi-Conductor Terminal Blocks

Description	Color	Number of Positions	Standard Pack	XBPT25D12 Catalog Number	XBPT4D12 Catalog Number	XBPT25D22 Catalog Number	XBPT4D22 Catalog Number
End cover	Gray	—	10	<b>XBACPT25D12</b>	<b>XBACPT4D12</b>	<b>XBACPT25D22</b>	<b>XBACPT4D22</b>
End cover segment	Gray	—	10	<b>XBASPT25</b>	<b>XBASPT4</b>	<b>XBASPT25</b>	<b>XBASPT4</b>
Partition plate	—	—	10	<b>XBATPTD12</b>	<b>XBATPTD12</b>	<b>XBATPTD22</b>	<b>XBATPTD22</b>
Plug-in bridge—for cross connections in the bridge shaft	Red	2	10	<b>XBAFBS25</b>	<b>XBAFBS26</b>	<b>XBAFBS25</b>	<b>XBAFBS26</b>
		3	10	<b>XBAFBS35</b>	<b>XBAFBS36</b>	<b>XBAFBS35</b>	<b>XBAFBS36</b>
		5	10	<b>XBAFBS55</b>	<b>XBAFBS56</b>	<b>XBAFBS55</b>	<b>XBAFBS56</b>
		10	10	<b>XBAFBS105</b>	<b>XBAFBS106</b>	<b>XBAFBS105</b>	<b>XBAFBS106</b>
		50	10	<b>XBAFBS505</b>	<b>XBAFBS506</b>	<b>XBAFBS505</b>	<b>XBAFBS506</b>
Test adapter	—	—	10	<b>XBATSPA14</b>	<b>XBATSPA14</b>	<b>XBATSPA14</b>	<b>XBATSPA14</b>
2.3 mm diameter test plug	—	—	—	<b>XBATSMPS-<sup>②</sup></b>	<b>XBATSMPS-<sup>②</sup></b>	<b>XBATSMPS-<sup>②</sup></b>	<b>XBATSMPS-<sup>②</sup></b>
Modular test plug	—	—	10	<b>XBATSPS5</b>	<b>XBATSPS6</b>	<b>XBATSPS5</b>	<b>XBATSPS6</b>
Blank marker strip external labeling	White	—	10	<b>XBMZBF5<sup>③</sup></b>	<b>XBMZBF6<sup>③</sup></b>	<b>XBMZBF5<sup>③</sup></b>	<b>XBMZBF6<sup>③</sup></b>
Blank marker strip center labeling (strip of 10)	White	—	10	<b>XBMZB5<sup>③</sup></b>	<b>XBMZB6<sup>③</sup></b>	<b>XBMZB5<sup>③</sup></b>	<b>XBMZB6<sup>③</sup></b>

#### Notes

① EU type—examination certificate number: KEMA 05ATEX2154 U (XBPT25D22), KEMA 05ATEX2155 (XBPT4D22).

② For ordering information, see **Page V7-T42-105**.

③ For information on Printed Marking Tag Options, see **Page V7-T42-98**.

For additional accessories, see **Page V7-T42-90**.



## Technical Data and Specifications

### Spring Cage Connection Multi-Conductor Terminal Blocks

Description	XBPT25D12	XBPT4D12	XBPT25D22	XBPT4D22
<b>Technical Data in Accordance with IEC</b>				
Maximum load current in A/cross-section in mm <sup>2</sup>	28/4	40/6	28/4	40/6
Rated surge voltage in kV/contamination class	8/3	8/3	8/3	8/3
Surge voltage category/insulating material group	III/I	III/I	III/I	III/I
<b>Connection Capacity</b>				
Stranded with ferrule with plastic sleeve in mm <sup>2</sup>	0.25–2.5	0.25–4	0.25–2.5	0.25–4
Stranded with ferrules without plastic sleeve in mm <sup>2</sup>	0.25–2.5	0.25–4	0.25–2.5	0.25–4
Stranded with twin ferrule with plastic sleeve in mm <sup>2</sup>	0.5	0.5–1	0.5	0.5–1
Stripping length in inches (mm)	0.39 (10)	0.39 (10)	0.39 (10)	0.39 (10)

## Dimensions

Approximate Dimensions in Inches (mm)

### Spring Cage Connection Multi-Conductor Terminal Blocks

Catalog Number	Width	Length	Cover Width	Height for—	
				35 x 7.5 in	35 x 15 in
XBPT25D12	0.20 (5.2)	2.38 (60.5)	0.09 (2.2)	1.44 (36.5)	1.73 (44.0)
XBPT4D12	0.24 (6.2)	2.81 (71.5)	0.09 (2.2)	1.44 (36.5)	1.73 (44.0)
XBPT25D22	0.20 (5.2)	2.83 (72.0)	0.09 (2.2)	1.44 (36.5)	1.73 (44.0)
XBPT4D22	0.24 (6.2)	3.43 (87.0)	0.09 (2.2)	1.44 (36.5)	1.73 (44.0)

#### Multi-Conductor Terminal Blocks



#### Contents

<b>Description</b>	<b>Page</b>
Single Level—Through-Feed .....	<b>V7-T42-32</b>
Single Level—Ground Blocks .....	<b>V7-T42-37</b>
Multi-Conductor Terminal Blocks .....	<b>V7-T42-39</b>
Multi-Conductor Ground Blocks	
Accessories .....	<b>V7-T42-43</b>
Technical Data and Specifications .....	<b>V7-T42-43</b>
Dimensions .....	<b>V7-T42-43</b>
Double Level Blocks .....	<b>V7-T42-44</b>
Triple Level Blocks .....	<b>V7-T42-46</b>
Fuse Terminal Blocks .....	<b>V7-T42-48</b>
Disconnect and Component Terminal Blocks .....	<b>V7-T42-51</b>
Hybrid Terminal Blocks .....	<b>V7-T42-54</b>
Mini Spring Cage .....	<b>V7-T42-56</b>

#### Multi-Conductor Ground Blocks

##### Product Description

The ground terminal blocks have the same shape and pitch as the standard terminal block, in a green-yellow housing. They easily snap

onto the DIN rail to make a reliable mechanical and electrical contact that meets all requirements of IEC 60-947-7-2.

##### Product Selection

###### XBPT25D12PE



##### Spring Cage Connection Multi-Conductor Ground Blocks, Three-Wire

Terminal Width	Maximum Wire Size	IEC 60 947-7-2 in V/A/AWG	EN 50 019 ① in V/A/AWG	UL-cUL Ratings in V/A/AWG	Color	Standard Pack	Catalog Number
5.2 mm	12 AWG/2.5 mm <sup>2</sup>	—/—/28-12	—/—/24-12	—/—/26-12	Green/Yellow	50	XBPT25D12PE
6.2 mm	10 AWG/4 mm <sup>2</sup>	—/—/28-10	—/—/24-10	—/—/20-10	Green/Yellow	50	XBPT4D12PE

###### XBPT4D22PE



##### Spring Cage Connection Multi-Conductor Ground Blocks, Four-Wire

Terminal Width	Maximum Wire Size	IEC 60 947-7-2 in V/A/AWG	EN 50 019 ① in V/A/AWG	UL-cUL Ratings in V/A/AWG	Color	Standard Pack	Catalog Number
5.2 mm	12 AWG/2.5 mm <sup>2</sup>	—/—/28-12	—/—/24-12	—/—/26-12	Green/Yellow	50	XBPT25D22PE
6.2 mm	10 AWG/4 mm <sup>2</sup>	—/—/28-10	—/—/24-10	—/—/20-10	Green/Yellow	50	XBPT4D22PE

##### Note

① EU type—examination certificate number: KEMA 05ATEX2154 U (XBPT25D12PE), KEMA 05ATEX2155 U (XBPT4D12PE).

## Accessories

### Spring Cage Connection Multi-Conductor Ground Blocks

Description	Color	Number of Positions	Standard Pack	XBPT25D12PE	XBPT4D12PE	XBPT25D22PE	XBPT4D22PE
				Catalog Number	Catalog Number	Catalog Number	Catalog Number
End cover	Gray	—	10	XBACPT25D12	XBACPT4D12	XBACPT25D22	XBACPT4D22
End cover segment	Gray	—	10	XBASPT25	XBASPT4	XBASPT25	XBASPT4
Blank marker strip external labeling	White	—	10	XBMZBF5 ①	XBMZBF6 ①	XBMZBF5 ①	XBMZBF6 ①
Blank marker strip center labeling (strip of 10)	White	—	10	XBMZB5 ①	XBMZB6 ①	XBMZB5 ①	XBMZB6 ①

## Technical Data and Specifications

### Spring Cage Connection Multi-Conductor Ground Blocks

Description	XBPT25D12PE	XBPT4D12PE	XBPT25D22PE	XBPT4D22PE
<b>Technical Data in Accordance with IEC</b>				
Maximum load current in A/cross-section in mm <sup>2</sup>	—	—	—	—
Rated surge voltage in kV/contamination class	8/3	8/3	8/3	8/3
Surge voltage category/insulating material group	III/1	III/1	III/1	III/1
<b>Connection Capacity</b>				
Stranded with ferrule with plastic sleeve in mm <sup>2</sup>	0.25–2.5	0.25–4	0.25–2.5	0.25–4
Stranded with ferrules without plastic sleeve in mm <sup>2</sup>	0.25–2.5	0.25–4	0.25–2.5	0.25–4
Stranded with twin ferrule with plastic sleeve in mm <sup>2</sup>	0.5	0.5–1	0.5	0.5–1
Stripping length in inches (mm)	0.39 (10)	0.39 (10)	0.39 (10)	0.39 (10)

## Dimensions

Approximate Dimensions in Inches (mm)

### Spring Cage Connection Multi-Conductor Ground Blocks

Catalog Number	Width	Length	Cover Width	Height for—	
				35 x 7.5 in	35 x 15 in
XBPT25D12PE	0.20 (5.2)	2.38 (60.5)	0.09 (2.2)	1.44 (36.5)	1.73 (44.0)
XBPT4D12PE	0.24 (6.2)	2.81 (71.5)	0.09 (2.2)	1.44 (36.5)	1.73 (44.0)
XBPT25D22PE	0.20 (5.2)	2.83 (72.0)	0.09 (2.2)	1.44 (36.5)	1.73 (44.0)
XBPT4D22PE	0.24 (6.2)	3.43 (87.0)	0.09 (2.2)	1.44 (36.5)	1.73 (44.0)

#### Notes

① For information on Printed Marking Tag Options, see **Page V7-T42-98**.

For additional accessories, see **Page V7-T42-90**.

#### Double Level Blocks



#### Contents

<i>Description</i>	<i>Page</i>
Single Level—Through-Feed . . . . .	<b>V7-T42-32</b>
Single Level—Ground Blocks . . . . .	<b>V7-T42-37</b>
Multi-Conductor Terminal Blocks . . . . .	<b>V7-T42-39</b>
Multi-Conductor Ground Blocks . . . . .	<b>V7-T42-42</b>
Double Level Blocks	
Accessories . . . . .	<b>V7-T42-45</b>
Technical Data and Specifications . . . . .	<b>V7-T42-45</b>
Dimensions . . . . .	<b>V7-T42-45</b>
Triple Level Blocks . . . . .	<b>V7-T42-46</b>
Fuse Terminal Blocks . . . . .	<b>V7-T42-48</b>
Disconnect and Component Terminal Blocks . . . . .	<b>V7-T42-51</b>
Hybrid Terminal Blocks . . . . .	<b>V7-T42-54</b>
Mini Spring Cage . . . . .	<b>V7-T42-56</b>

### Double Level Blocks

#### Product Description

The potentials of the **XB** double level terminal blocks routed on two levels reduce space requirements by 50% compared with single level terminal blocks.

The XBPTT blocks can be bridged on both levels with the Plug-in bridge system and labeling options are available for each terminal point, resulting in maximum

customization for each application. The XBPTT25PV and XBPTT4PV terminal blocks have two interconnected levels.

Equipotential bonding is marked by an imprint on the housing. These terminal blocks can also be bridged and used to construct compact potential distributor blocks.

#### Product Selection

##### XBPTT4



#### Spring Cage Connection Double Level Blocks

Terminal Width	Maximum Wire Size	IEC 60 947-7-1 in V/A/AWG	EN 50 019 ① in V/A/AWG	UL-cUL Ratings in V/A/AWG	Color	Standard Pack	Catalog Number
<b>Spring Cage Connection Double Level Blocks</b>							
5.2 mm	12 AWG/2.5 mm <sup>2</sup>	500/26/28-12	420/23/19/24-12	600/20/26-12	Gray	50	<b>XBPTT25</b>
					Blue	50	<b>XBPTT25BU</b>
6.2 mm	10 AWG/4 mm <sup>2</sup>	500/32/28-10	420/32/27/24-10	300/30/20-10	Gray	50	<b>XBPTT4</b>
					Blue	50	<b>XBPTT4BU</b>
<b>Spring Cage Connection Double Level Blocks</b> (terminal block with potential distribution between the levels)							
5.2 mm	112 AWG/2.5 mm <sup>2</sup>	500/26/28-12	420/23/19/24-12	600/20/26-12	Gray	50	<b>XBPTT25PV</b>
					Gray	50	<b>XBPTT4PV</b>

##### XBPTT25PE



#### Spring Cage Connection Double Level Ground Blocks

Terminal Width	Maximum Wire Size	IEC 60 947-7-2 in V/A/AWG	EN 50 019 ① in V/A/AWG	UL-cUL Ratings in V/A/AWG	Color	Standard Pack	Catalog Number
5.2 mm	12 AWG/2.5 mm <sup>2</sup>	—/—/28-12	—/—/24-12	—/—/26-12	Green/Yellow	50	<b>XBPTT25PE</b>
					Green/Yellow	50	<b>XBPTT4PE</b>

#### Note

① EU type—examination certificate number: KEMA 05ATEX2154 U (XBPTT25), KEMA 05ATEX2155 U (XBPTT4).

## Accessories

### Spring Cage Connection Double Level Blocks

Description	Color	Number of Positions	Standard Pack	XBPTT25 Catalog Number	XBPTT4 Catalog Number	XBPTT25PE Catalog Number	XBPTT4PE Catalog Number
End cover	Gray	—	10	<b>XBACPTT25</b>	<b>XBACPTT4</b>	<b>XBACPTT25</b>	<b>XBACPTT4</b>
Partition plate	—	—	10/50	<b>XBATPTT4</b>	<b>XBATPTT4</b>	—	—
Plug-in bridge—for cross connections in the bridge shaft	Red	2	10	<b>XBAFBS25</b>	<b>XBAFBS26</b>	<b>XBAFBS25</b>	<b>XBAFBS26</b>
		3	10	<b>XBAFBS35</b>	<b>XBAFBS36</b>	<b>XBAFBS35</b>	<b>XBAFBS36</b>
		5	10	<b>XBAFBS55</b>	<b>XBAFBS56</b>	<b>XBAFBS55</b>	<b>XBAFBS56</b>
		10	10	<b>XBAFBS105</b>	<b>XBAFBS106</b>	<b>XBAFBS105</b>	<b>XBAFBS106</b>
		50	10	<b>XBAFBS505</b>	<b>XBAFBS506</b>	<b>XBAFBS505</b>	<b>XBAFBS506</b>
Test adapter	—	—	10	<b>XBATSPAI4</b>	<b>XBATSPAI4</b>	—	—
Modular test plug	—	—	10	<b>XBATSPS5</b>	<b>XBATSPS6</b>	—	—
Blank marker strip (strip of 10)	White	—	10	<b>XBMZBF5</b> ①	<b>XBMZBF6</b> ①	<b>XBMZBF5</b> ①	<b>XBMZBF6</b> ①

## Technical Data and Specifications

### Spring Cage Connection Double Level Blocks

Description	XBPTT25	XBPTT4	XBPTT25PE	XBPTT4PE
<b>Technical Data in Accordance with IEC</b>				
Maximum load current in A/cross-section in mm <sup>2</sup>	26/4	32/6	—	—
Rated surge voltage in kV/contamination class	6/3	6/3	6/3	6/3
Surge voltage category/insulating material group	III/I	III/I	III/I	III/I
<b>Connection Capacity</b>				
Stranded with ferrule with plastic sleeve in mm <sup>2</sup>	0.25–2.5	0.25–4	0.25–2.5	0.25–4
Stranded with ferrules without plastic sleeve in mm <sup>2</sup>	0.25–2.5	0.25–4	0.25–2.5	0.25–4
Stranded with twin ferrule with plastic sleeve in mm <sup>2</sup>	0.5	0.5–1	0.5	0.5–1
Stripping length in inches (mm)	0.39 (10)	0.39 (10)	0.39 (10)	0.39 (10)

## Dimensions

Approximate Dimensions in Inches (mm)

### Spring Cage Connection Double Level Blocks

Catalog Number	Width	Length	Cover Width	Height for—	
				35 x 7.5 in	35 x 15 in
<b>XBPTT25</b>	0.20 (5.2)	2.66 (67.5)	0.09 (2.2)	1.87 (47.5)	2.17 (55.0)
<b>XBPTT4</b>	0.24 (6.2)	3.29 (83.5)	0.09 (2.2)	1.87 (47.5)	2.17 (55.0)
<b>XBPTT25PE</b>	0.20 (5.2)	2.66 (67.5)	0.09 (2.2)	1.87 (47.5)	2.17 (55.0)
<b>XBPTT4PE</b>	0.24 (6.2)	3.29 (83.5)	0.09 (2.2)	1.87 (47.5)	2.17 (55.0)

#### Notes

① For information on Printed Marking Tag Options, see **Page V7-T42-98**.

For additional accessories, see **Page V7-T42-90**.

#### Triple Level Blocks

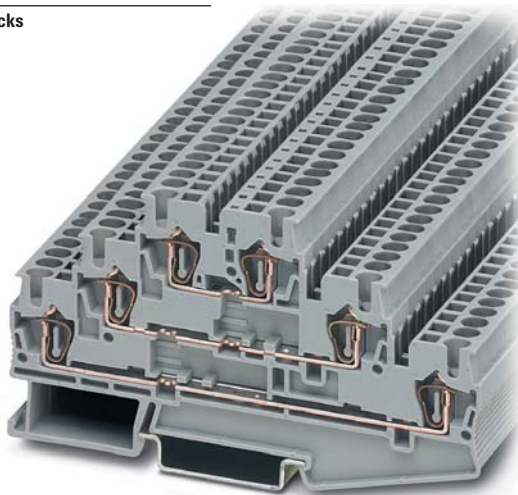

### Contents

<i>Description</i>	<i>Page</i>
Single Level—Through-Feed . . . . .	<b>V7-T42-32</b>
Single Level—Ground Blocks . . . . .	<b>V7-T42-37</b>
Multi-Conductor Terminal Blocks . . . . .	<b>V7-T42-39</b>
Multi-Conductor Ground Blocks . . . . .	<b>V7-T42-42</b>
Double Level Blocks . . . . .	<b>V7-T42-44</b>
Triple Level Blocks	
Accessories . . . . .	<b>V7-T42-47</b>
Technical Data and Specifications . . . . .	<b>V7-T42-47</b>
Dimensions . . . . .	<b>V7-T42-47</b>
Fuse Terminal Blocks . . . . .	<b>V7-T42-48</b>
Disconnect and Component Terminal Blocks . . . . .	<b>V7-T42-51</b>
Hybrid Terminal Blocks . . . . .	<b>V7-T42-54</b>
Mini Spring Cage . . . . .	<b>V7-T42-56</b>

### Triple Level Blocks

#### Product Description

The spring cage triple level terminal block incorporates three feed-through levels in a 5.2 mm wide housing. This is ideal for high density wiring, especially important

when switchgear space is restricted. There is a bridge shaft on each level allowing use of this block as a compact potential distributor or as a sensor terminal.

The XBPTK25PV has all six terminal points interconnected. All the triple level blocks can be labeled on each level.

#### Product Selection

##### XBPTK25



#### Spring Cage Connection Triple Level Blocks

Terminal Width	Maximum Wire Size	IEC 60 947-7-1 in V/A/AWG	UL-cUL Ratings in V/A/AWG	Color	Standard Pack	Catalog Number
5.2 mm	12 AWG/2.5 mm <sup>2</sup>	500/28/28-12	600/20/26-12	Gray	50	<b>XBPTK25</b>
5.2 mm	12 AWG/2.5 mm <sup>2</sup>	500/28/28-12	600/20/26-12	Gray	50	<b>XBPTK25PV</b> ①

#### Note

① Terminal block with potential distribution between the levels.

## Accessories

### Spring Cage Connection Triple Level Blocks

Description	Color	Number of Positions	Standard Pack	XBPTK25 Catalog Number	XBPTK25PV Catalog Number
End cover	Gray	—	10	<b>XBACPT25K</b>	<b>XBACPT25K</b>
Plug-in bridge—for cross connections in the bridge shaft	Red	2	10	<b>XBAFBS25</b>	<b>XBAFBS25</b>
		3	10	<b>XBAFBS35</b>	<b>XBAFBS35</b>
		5	10	<b>XBAFBS55</b>	<b>XBAFBS55</b>
		10	10	<b>XBAFBS105</b>	<b>XBAFBS105</b>
		50	10	<b>XBAFBS505</b>	<b>XBAFBS505</b>
Test adapter	—	—	10	<b>XBATSPA14</b>	<b>XBATSPA14</b>
Modular test plug	—	—	10	<b>XBATSPS5</b>	<b>XBATSPS5</b>
Blank marker strip (strip of 10)	White	—	10	<b>XBMZBF5</b> ①	<b>XBMZBF5</b> ①

## Technical Data and Specifications

### Spring Cage Connection Triple Level Blocks

Description	XBPTK25	XBPTK25PV
<b>Technical Data in Accordance with IEC</b>		
Maximum load current in A/cross-section in mm <sup>2</sup>	28/4	28/4
Rated surge voltage in kV/contamination class	6/3	6/3
Surge voltage category/insulating material group	III/I	III/I
<b>Connection Capacity</b>		
Stranded with ferrule with plastic sleeve in mm <sup>2</sup>	0.25–2.5	0.25–2.5
Stranded with ferrules without plastic sleeve in mm <sup>2</sup>	0.25–2.5	0.25–2.5
Stranded with twin ferrule with plastic sleeve in mm <sup>2</sup>	0.5	0.5
Stripping length in inches (mm)	0.39 (10)	0.39 (10)

## Dimensions

Approximate Dimensions in Inches (mm)

### Spring Cage Connection Triple Level Blocks

Catalog Number	Width	Length	Cover Length	Height for—	
				35 x 7.5 in	35 x 15 in
<b>XBPTK25</b>	0.20 (5.2)	3.92 (99.5)	0.09 (2.2)	2.28 (58.0)	2.58 (65.5)
<b>XBPTK25PV</b>	0.20 (5.2)	3.92 (99.5)	0.09 (2.2)	2.28 (58.0)	2.58 (65.5)

#### Notes

① For information on Printed Marking Tag Options, see **Page V7-T42-98**.

For additional accessories, see **Page V7-T42-90**.



#### Fuse Terminal Blocks



42

#### Contents

<i>Description</i>	<i>Page</i>
Single Level—Through-Feed .....	<b>V7-T42-32</b>
Single Level—Ground Blocks .....	<b>V7-T42-37</b>
Multi-Conductor Terminal Blocks .....	<b>V7-T42-39</b>
Multi-Conductor Ground Blocks .....	<b>V7-T42-42</b>
Double Level Blocks .....	<b>V7-T42-44</b>
Triple Level Blocks .....	<b>V7-T42-46</b>
Fuse Terminal Blocks	
Accessories .....	<b>V7-T42-49</b>
Technical Data and Specifications .....	<b>V7-T42-50</b>
Dimensions .....	<b>V7-T42-50</b>
Disconnect and Component Terminal Blocks .....	<b>V7-T42-51</b>
Hybrid Terminal Blocks .....	<b>V7-T42-54</b>
Mini Spring Cage .....	<b>V7-T42-56</b>

### Fuse Terminal Blocks

#### Product Description

The spring cage fuse terminal blocks act as a fuse carrier for 5 x 20 mm or 6.3 x 32 mm fuses. They also allow for potential distribution with the

double bridge shaft. For signaling a triggered fuse, fuse terminal blocks with light indicators are available (for both AC and DC voltage).

#### Product Selection

XBPT4FBE

#### Spring Cage Connection Fuse Terminal Blocks, for 5 x 20 mm Fuse



Terminal Width	Maximum Wire Size	IEC 60 947-7-3 with Fuse in V/A/AWG	IEC 60 947-7-3 as Disconnect Terminal Blocks in V/A/AWG	UL-cUL Ratings in V/A/AWG	Color	Standard Pack	Catalog Number
<b>Fuse Terminal Blocks</b>							
6.2 mm	10 AWG/4 mm <sup>2</sup>	①/①/28-10	250/6.3/28-10	300/6.3/24-10	Black	50	<b>XBPT4FBE</b>
<b>Fuse Terminal Blocks with LED 15-30V, 3.5-8.1A</b>							
6.2 mm	10 AWG/4 mm <sup>2</sup>	①/①/28-10	250/6.3/28-10	300/6.3/24-10	Black	50	<b>XBPT4FBEL24</b>
<b>Fuse Terminal Blocks with LED 30-60V, 0.8-2.0A</b>							
6.2 mm	10 AWG/4 mm <sup>2</sup>	①/①/28-10	250/6.3/28-10	300/6.3/24-10	Black	50	<b>XBPT4FBEL60</b>
<b>Fuse Terminal Blocks with LED 110-250V, 0.5-1.0A</b>							
6.2 mm	10 AWG/4 mm <sup>2</sup>	①/①/28-10	250/6.3/28-10	300/6.3/24-10	Black	50	<b>XBPT4FBEL250</b>

#### Notes

The cartridge fuse holders should be selected according to the maximum power dissipation (self-heating) of the cartridge fuse inserts. The thermal conditions in closed fuse holes should be checked according to the application and installation.

Higher ambient temperatures are an additional strain on fuse inserts. In applications of this kind, the shift of the rated current should be taken into consideration accordingly.

Maximum power dissipation at 73.4°F (23°C) (in accordance with IEC 60 947-7-3).

When selecting cartridge fuse inserts, please ensure that the maximum power dissipation specified at right is not exceeded. Details can be obtained from the fuse suppliers.

Cartridge Fuse Inserts 5 x 20 and 6.3 x 32 mm in accordance with IEC 60 947-7-3.

① The current is determined by the fuse used, the voltage by the selected light indicator. See **Page V7-T42-49**.



## XBPT4FBN

## Spring Cage Connection Fuse Terminal Blocks, for 6.3 x 32 mm (1/4 in x 1-1/4 in) Fuse



Terminal Width	Maximum Wire Size	IEC 60 947-7-3 with Fuse in V/A/AWG	IEC 60 947-7-3 as Disconnect Terminal Blocks in V/A/AWG	UL-cUL Ratings in V/A/AWG	Color	Standard Pack	Catalog Number
<b>Fuse Terminal Blocks</b>							
8.2 mm	10 AWG/4 mm <sup>2</sup>	400/10/28-10	400/10/28-10	300/10/24-10	Black	50	<b>XBPT4FBN</b>
<b>Fuse Terminal Blocks with LED 12-30V, 1.0-2.5 mA</b>							
8.2 mm	10 AWG/4 mm <sup>2</sup>	400/10/28-10	400/10/28-10	300/10/24-10	Black	50	<b>XBPT4FBNL24</b>
<b>Fuse Terminal Blocks with LED 110-250V, 0.5-2.5 mA</b>							
8.2 mm	10 AWG/4 mm <sup>2</sup>	400/10/28-10	400/10/28-10	300/10/24-10	Black	50	<b>XBPT4FBNL250</b>

## Accessories

## Spring Cage Connection Fuse Terminal Blocks

Description	Color	Number of Positions	Standard Pack	XBPT4FBE Catalog Number	XBPT4FBN Catalog Number
Partition plate	—	—	10	<b>XBATPT4</b>	<b>XBATQTD12</b>
Plug-in bridge—for cross connections in the bridge shaft	Red	2	10	<b>XBAFBS26</b>	<b>XBAFBS28</b>
		3	10	<b>XBAFBS36</b>	—
		5	10	<b>XBAFBS56</b>	—
		10	10	<b>XBAFBS106</b>	—
Blank marker strip external labeling	White	—	10	<b>XBMZBF6</b> ①	<b>XBMZBF8</b> ①
Blank marker strip center labeling (strip of 10)	White	—	10	<b>XBMZB5</b> ①	<b>XBMZB6</b> ①

**Notes**

The cartridge fuse holders should be selected according to the maximum power dissipation (self-heating) of the cartridge fuse inserts. The thermal conditions in closed fuse holes should be checked according to the application and installation.

Higher ambient temperatures are an additional strain on fuse inserts. In applications of this kind, the shift of the rated current should be taken into consideration accordingly.

Maximum power dissipation at 73.4°F (23°C) (in accordance with IEC 60 947-7-3).

When selecting cartridge fuse inserts, please ensure that the maximum power dissipation specified at right is not exceeded. Details can be obtained from the fuse suppliers.

Cartridge Fuse Inserts 5 x 20 and 6.3 x 32 mm in accordance with IEC 60 947-7-3.

① For information on Printed Marking Tag Options, see **Page V7-T42-98**.

For additional accessories, see **Page V7-T42-90**.

### Technical Data and Specifications

#### Overload and Short-Circuit Protection

Terminal Blocks	U (V)	Overload Protection		Short-Circuit Protection Only		I <sub>max</sub> (A)
		Individual	Interconnected	Individual	Interconnected	
<b>XBPT4FBN</b>	400	1.6W	1.6W	4W	2.5W	10.0
<b>XBPT4FBE</b>	250	1.6W	1.6W	4W	2.5W	6.3

#### Spring Cage Connection Fuse Terminal Blocks

Description	XBPT4FBE	XBPT4FBN
<b>Technical Data in Accordance with IEC</b>		
Fuse type/dimensions in mm <sup>2</sup>	G/5 x 20	G/6.3 x 32
Maximum current with single arrangement in A	6.3	10
<b>Maximum Power Dissipation</b>		
At 73.4°F (23°C) in accordance with IEC 60 947-7-3 in W	①	①
Rated surge voltage in kV/contamination class	4/3	6/3
Surge voltage category/insulating material group	III/I	III/I
<b>Connection Capacity</b>		
Stranded with ferrule/with ferrule and plastic sleeve in mm <sup>2</sup>	0.25–4/0.25–4	0.25–4/0.25–4
Stranded with twin ferrule and plastic sleeve in mm <sup>2</sup>	0.5	0.5
Stripping length in inches (mm)	0.39 (10)	0.39 (10)

### Dimensions

Approximate Dimensions in Inches (mm)

#### Spring Cage Connection Fuse Terminal Blocks

Catalog Number	Width	Length	Height for—	
			35 x 7.5 in	35 x 15 in
<b>XBPT4FBE</b>	0.24 (6.2)	2.42 (61.5)	2.46 (62.5)	2.76 (70.0)
<b>XBPT4FBN</b>	0.32 (8.2)	3.01 (76.5)	2.72 (69.0)	3.01 (76.5)

#### Note

① The current is determined by the fuse used, the voltage by the selected light indicator. See **Page V7-T42-49**.

## Disconnect and Component Terminal Blocks

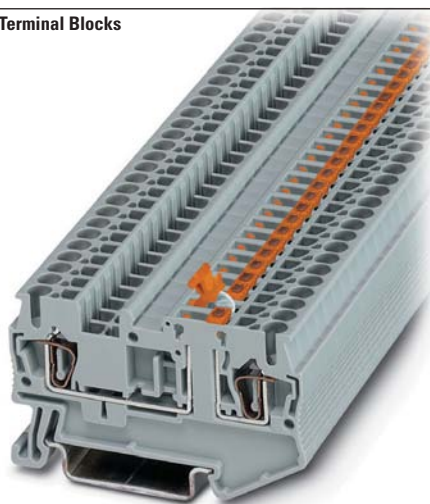

## Contents

Description	Page
Single Level—Through-Feed	V7-T42-32
Single Level—Ground Blocks	V7-T42-37
Multi-Conductor Terminal Blocks	V7-T42-39
Multi-Conductor Ground Blocks	V7-T42-42
Double Level Blocks	V7-T42-44
Triple Level Blocks	V7-T42-46
Fuse Terminal Blocks	V7-T42-48
Disconnect and Component Terminal Blocks	
Accessories	V7-T42-52
Technical Data and Specifications	V7-T42-53
Dimensions	V7-T42-53
Hybrid Terminal Blocks	V7-T42-54
Mini Spring Cage	V7-T42-56

## Disconnect and Component Terminal Blocks

## Product Description

The XBPT knife disconnect terminal blocks feature narrow construction and high current carrying capacity. They also have a test connection parallel to the disconnect point for a 2.3 mm

diameter test plug. Potential distribution is easily accomplished with the Plug-in bridges. There are front connection spring cage terminal blocks available for multi-conductor connections

in the smallest possible space. The XBPT4TG disconnect terminal block accommodates component plugs for resistors, diodes, or capacitors, and fuse plugs with or without indication.

## Product Selection

XBPT25MT  
Knife Disconnect

## Disconnect and Component Terminal Blocks

Terminal Width	Maximum Wire Size	IEC 60 947-7-1 in V/A/AWG	UL-cUL Ratings in V/A/AWG	Color	Standard Pack	Catalog Number
<b>Single Level Knife Disconnect</b>						
5.2 mm	12 AWG/2.5 mm <sup>2</sup>	400/16/28–12	600/16/26–12	Gray	50	XBPT25MT
6.2 mm	10 AWG/4 mm <sup>2</sup>	400/16/28–10	300/6.3/24–10	Gray	50	XBPT4MT
<b>Three-Wire Knife Disconnect</b>						
5.2 mm	12 AWG/2.5 mm <sup>2</sup>	400/16/28–12	600/16/26–12	Gray	50	XBPT25D12MT
<b>Four-Wire Knife Disconnect</b>						
5.2 mm	12 AWG/2.5 mm <sup>2</sup>	400/16/28–12	600/16/26–12	Gray	50	XBPT25D22MT
<b>Spring Cage Disconnect/Component Plug</b>						
6.2 mm	10 AWG/4 mm <sup>2</sup>	400/16/28–10	300/6.3/24–10	Gray	50	XBPT4TG
<b>Component Plug</b>						
6.2 mm	10 AWG/4 mm <sup>2</sup>	400/16/28–10	300/6.3/24–10	Gray	10	XBPCO
<b>Fuse Plug</b>						
6.2 mm	10 AWG/4 mm <sup>2</sup>	400/16/28–10	300/6.3/24–10	Black	10	XBPFU
<b>Fuse Plug with Light Indicator for 12–30V, 1–2.5 mA</b>						
6.2 mm	10 AWG/4 mm <sup>2</sup>	400/16/28–10	300/6.3/24–10	Black	10	XBPFUL24
<b>Fuse Plug with Light Indicator for 110–250V, 0.5–2.5 mA</b>						
6.2 mm	10 AWG/4 mm <sup>2</sup>	400/16/28–10	300/6.3/24–10	Black	10	XBPFUL250

#### Accessories

#### Spring Cage Connection Disconnect and Component Terminal Blocks

Description	Color	Number of Positions	Standard Pack	XBPT25MT Catalog Number	XBPT25D12MT Catalog Number	XBPT25D22MT Catalog Number	XBPT4MT Catalog Number	XBPT4TG Catalog Number
End cover	Gray	—	10	<b>XBACPT25D12</b>	<b>XBACPT25D22</b>	<b>XBACPT25D22MT</b>	③	③
End cover segment	Gray	—	10	—	<b>XBACPT25</b>	<b>XBACPT25</b>	—	—
Partition plate	—	—	—	<b>XBATPTD12</b>	<b>XBATPTD22</b>	—	<b>XBATPT4</b>	<b>XBATPT4</b>
Plug-in bridge—for cross connections in the terminal center	Red	2	10	<b>XBAFBS25</b>	<b>XBAFBS25</b>	<b>XBAFBS25</b>	<b>XBAFBS26</b>	<b>XBAFBS26</b>
		3	10	<b>XBAFBS35</b>	<b>XBAFBS35</b>	<b>XBAFBS35</b>	<b>XBAFBS36</b>	<b>XBAFBS36</b>
		5	10	<b>XBAFBS55</b>	<b>XBAFBS55</b>	<b>XBAFBS55</b>	<b>XBAFBS56</b>	<b>XBAFBS56</b>
		10	10	<b>XBAFBS105</b>	<b>XBAFBS105</b>	<b>XBAFBS105</b>	<b>XBAFBS106</b>	<b>XBAFBS106</b>
		50	10	<b>XBAFBS505</b>	<b>XBAFBS505</b>	<b>XBAFBS505</b>	<b>XBAFBS506</b>	<b>XBAFBS506</b>
Test adapter	—	—	10	<b>XBATSPA14</b>	<b>XBATSPA14</b>	<b>XBATSPA14</b>	<b>XBATSPA14</b>	<b>XBATSPA14</b>
2.3 mm diameter test plug	—	—	—	<b>XBATSMPS-<sup>①</sup></b>	<b>XBATSMPS-<sup>①</sup></b>	<b>XBATSMPS-<sup>①</sup></b>	<b>XBATSMPS-<sup>①</sup></b>	<b>XBATSMPS-<sup>①</sup></b>
Modular test plug	—	—	10	<b>XBATSPS5</b>	<b>XBATSPS5</b>	<b>XBATSPS5</b>	<b>XBATSPS6</b>	<b>XBATSPS6</b>
Blank marker strip external labeling	White	—	10	<b>XBMZBF5<sup>②</sup></b>	<b>XBMZBF5<sup>②</sup></b>	<b>XBMZBF5<sup>②</sup></b>	<b>XBMZBF6<sup>②</sup></b>	<b>XBMZBF6<sup>②</sup></b>
Blank marker strip center labeling (strip of 10)	White	—	10	<b>XBMZB5<sup>②</sup></b>	<b>XBMZB5<sup>②</sup></b>	<b>XBMZB5<sup>②</sup></b>	<b>XBMZB6<sup>②</sup></b>	<b>XBMZB6<sup>②</sup></b>

#### Notes

- ① For ordering information, see **Page V7-T42-105**.
- ② For information on Printed Marking Tag Options, see **Page V7-T42-98**.
- ③ XBPT4MT and XBPT4TG have an enclosed design. The use of an end cover is not required.

For additional accessories, see **Page V7-T42-90**.

## Technical Data and Specifications

### Spring Cage Connection Disconnect and Component Terminal Blocks, XBPT25MT, XBPT25D12MT and XBPT25D22MT

Description	XBPT25MT	XBPT25D12MT	XBPT25D22MT
<b>Technical Data in Accordance with IEC</b>			
Maximum load current in A/cross-section in mm <sup>2</sup>	16/4	16/4	16/4
Rated surge voltage in kV/contamination class	6/3	6/3	6/3
Surge voltage category/insulating material group	III/1	III/1	III/1
<b>Connection Capacity</b>			
Stranded with ferrule with plastic sleeve in mm <sup>2</sup>	0.25–2.5	0.25–2.5	0.25–2.5
Stranded with ferrules without plastic sleeve in mm <sup>2</sup>	0.25–2.5	0.25–2.5	0.25–2.5
Stranded with twin ferrule with plastic sleeve in mm <sup>2</sup>	0.5	0.5	0.5
Stripping length in inches (mm)	0.39 (10)	0.39 (10)	0.39 (10)

### Spring Cage Connection Disconnect and Component Terminal Blocks, XBPT25D12MT and XBPT4TG

Description	XBPT4MT	XBPT4TG
<b>Technical Data in Accordance with IEC</b>		
Maximum load current in A/cross-section in mm <sup>2</sup>	16/6	16/6
Rated surge voltage in kV/contamination class	6/3	6/3
Surge voltage category/insulating material group	III/1	III/1
<b>Connection Capacity</b>		
Stranded with ferrule with plastic sleeve in mm <sup>2</sup>	0.25–4	0.25–4
Stranded with ferrules without plastic sleeve in mm <sup>2</sup>	0.25–4	0.25–4
Stranded with twin ferrule with plastic sleeve in mm <sup>2</sup>	0.5	0.5
Stripping length in inches (mm)	0.39 (10)	0.39 (10)

## Dimensions

Approximate Dimensions in Inches (mm)

### Spring Cage Connection Disconnect and Component Terminal Blocks

Catalog Number	Width	Length	Cover Length	Height for—	
				35 x 7.5 in	35 x 15 in
XBPT25MT	0.20 (5.2)	2.38 (60.5)	0.09 (2.2)	1.44 (36.5)	1.73 (44.0)
XBPT25D12MT	0.20 (5.2)	2.83 (72.0)	0.09 (2.2)	1.44 (36.5)	1.73 (44.0)
XBPT25D22MT	0.20 (5.2)	3.31 (84.0)	0.09 (2.2)	1.44 (36.5)	1.73 (44.0)
XBPT4MT	0.24 (6.2)	2.42 (61.5)	—	1.44 (36.5)	1.73 (44.0)
XBPT4TG	0.24 (6.2)	2.42 (61.5)	—	1.44 (36.5)	1.73 (44.0)

#### Hybrid Terminal Blocks



#### Contents

<i>Description</i>	<i>Page</i>
Single Level—Through-Feed .....	<b>V7-T42-32</b>
Single Level—Ground Blocks .....	<b>V7-T42-37</b>
Multi-Conductor Terminal Blocks .....	<b>V7-T42-39</b>
Multi-Conductor Ground Blocks .....	<b>V7-T42-42</b>
Double Level Blocks .....	<b>V7-T42-44</b>
Triple Level Blocks .....	<b>V7-T42-46</b>
Fuse Terminal Blocks .....	<b>V7-T42-48</b>
Disconnect and Component Terminal Blocks .....	<b>V7-T42-51</b>
Hybrid Terminal Blocks	
Accessories .....	<b>V7-T42-55</b>
Technical Data and Specifications .....	<b>V7-T42-55</b>
Dimensions .....	<b>V7-T42-55</b>
Mini Spring Cage .....	<b>V7-T42-56</b>

### Hybrid Terminal Blocks

#### Product Description

The XBPU spring cage hybrid terminal blocks offer the best of both worlds. One side offers a spring cage connection and the other side offers the universal screw connection. Use the spring

cage connection on the internal (factory) control cabinet side and the screw connection on the end customer (field) side. Ground terminal blocks of the same shape are also available.

#### Product Selection

##### XBPU25D12



#### Spring Cage Hybrid Terminal Blocks

Terminal Width	Maximum Wire Size	IEC 60 947-7-1 with ...		IEC 60 947-7-2 with ...		UL-cUL Ratings with ...		Color	Std. Pack	Catalog Number
		Spring in V/A/AWG	Screw in V/A/AWG	Spring in V/A/AWG	Screw in V/A/AWG	Spring in V/A/AWG	Screw in V/A/AWG			
5.2 mm	12 AWG/ 2.5 mm <sup>2</sup>	800/28/28-12	800/28/26-14	—	—	600/15/28-12	600/15/26-12	Gray	50	<b>XBPU25D12</b>

##### XBPU25D12PE

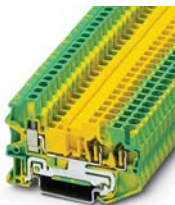

#### Spring Cage Hybrid Ground Blocks

Terminal Width	Maximum Wire Size	IEC 60 947-7-1 with ...		IEC 60 947-7-2 with ...		UL-cUL Ratings with ...		Color	Std. Pack	Catalog Number
		Spring in V/A/AWG	Screw in V/A/AWG	Spring in V/A/AWG	Screw in V/A/AWG	Spring in V/A/AWG	Screw in V/A/AWG			
5.2 mm	12 AWG/ 2.5 mm <sup>2</sup>	—	—	—/—/28-12	—/—/26-14	—/—/28-12	—/—/28-12	Green/ Yellow	50	<b>XBPU25D12PE</b>

## Accessories

### Spring Cage Hybrid Terminal/Ground Blocks

Description	Color	Number of Positions	Standard Pack	XBPU25D12 Catalog Number	XBPU25D12PE Catalog Number
End cover	Gray	—	10	<b>XBACPU25D12</b>	<b>XBACPU25D12</b>
Plug-in bridge—for cross connections in the terminal center	Red	2	10	<b>XBAFBS25</b>	<b>XBAFBS25</b>
		3	10	<b>XBAFBS35</b>	<b>XBAFBS35</b>
		5	10	<b>XBAFBS55</b>	<b>XBAFBS55</b>
		10	10	<b>XBAFBS105</b>	<b>XBAFBS105</b>
		50	10	<b>XBAFBS505</b>	<b>XBAFBS505</b>
Test adapter	—	—	10	<b>XBATSPAI4</b>	—
2.3 mm diameter test plug	—	—	—	<b>XBATSMPS-</b> <sup>①</sup>	—
Modular test plug	—	—	10	<b>XBATSPS5</b>	—
Blank marker strip external labeling	White	—	10	<b>XBMZBF5</b> <sup>②</sup>	<b>XBMZBF5</b> <sup>②</sup>
Blank marker strip center labeling (strip of 10)	White	—	10	<b>XBMZB5</b> <sup>②</sup>	<b>XBMZB5</b> <sup>②</sup>

42

## Technical Data and Specifications

### Spring Cage Hybrid Blocks

Description	XBPU25D12	XBPU25D12PE
<b>Technical Data in Accordance with IEC</b>		
Maximum load current in A/cross-section in mm <sup>2</sup>	28/4	—
Rated surge voltage in kV/contamination class	8/3	8/3
Surge voltage category/insulating material group	III/1	III/1
<b>Connection Capacity</b>		
Stranded with ferrule with plastic sleeve in mm <sup>2</sup>	0.25–2.5	0.25–2.5
Stranded with ferrules without plastic sleeve in mm <sup>2</sup>	0.25–2.5	0.25–2.5
Stranded with twin ferrule with plastic sleeve in mm <sup>2</sup>	0.5–1	0.5–1
Stripping length in inches (mm)	0.39 (10)	0.39 (10)

## Dimensions

Approximate Dimensions in Inches (mm)

### Spring Cage Hybrid Blocks

Catalog Number	Width	Length	Cover Length	Height for—	
				35 x 7.5 in	35 x 15 in
<b>XBPU25D12</b>	0.20 (5.2)	2.57 (65.3)	0.09 (2.2)	1.69 (42.8)	1.98 (50.3)
<b>XBPU25D12PE</b>	0.20 (5.2)	2.57 (65.3)	0.09 (2.2)	1.69 (42.8)	1.98 (50.3)

#### Notes

- ① For ordering information, see **Page V7-T42-105**.
  - ② For information on Printed Marking Tag Options, see **Page V7-T42-98**.
- For additional accessories, see **Page V7-T42-90**.

#### Mini Spring Cage



#### Contents

<i>Description</i>	<i>Page</i>
Single Level—Through-Feed	V7-T42-5
Single Level—Ground Blocks	V7-T42-10
Multi-Conductor Terminal Blocks	V7-T42-12
Multi-Conductor Ground Blocks	V7-T42-14
Double Level	V7-T42-16
Triple Level Sensor/Actuator	V7-T42-18
Fuse Terminal Blocks	V7-T42-21
Disconnect and Component Terminal Blocks	V7-T42-24
High Current Blocks	V7-T42-27
Mini Spring Cage	
Accessories	V7-T42-57
Technical Data and Specifications	V7-T42-57
Dimensions	V7-T42-57

### Mini Spring Cage

#### Product Description

The **XB** miniature terminal blocks have a connection cross-section from 1.5 mm<sup>2</sup> through 4 mm<sup>2</sup> and mount on 15 mm DIN rail. There is an

opening for bridging with a fixed bridge in the center of the terminal blocks. These miniature terminal blocks also offer the same accessories

that you would find with the larger blocks—including marking tags, end covers, end stop and ground blocks.

#### Product Selection

##### XBMPK15



#### Mini Spring Cage Terminal Blocks

Terminal Width	Maximum Wire Size	IEC 60 947-7-1 in V/A/AWG	IEC 60 947-7-2 in V/A/AWG	UL-cUL Ratings in V/A/AWG	Color	Standard Pack	Catalog Number
5.2 mm	14 AWG/1.5 mm <sup>2</sup>	800/24/26–14	—	600/15/26–14	Gray	50	<b>XBMPK15</b>
					Blue	50	<b>XBMPK15BU</b>

##### XBMPK15PE



#### Mini Spring Cage Ground Blocks

Terminal Width	Maximum Wire Size	IEC 60 947-7-1 in V/A/AWG	IEC 60 947-7-2 in V/A/AWG	UL-cUL Ratings in V/A/AWG	Color	Standard Pack	Catalog Number
5.2 mm	14 AWG/1.5 mm <sup>2</sup>	—	—/—/26–14	—/—/26–14	Green/ Yellow	50	<b>XBMPK15PE</b>

##### XBMPKK15



#### Mini Spring Cage Terminal Blocks—Double Level

Terminal Width	Maximum Wire Size	IEC 60 947-7-1 in V/A/AWG	UL-cUL Ratings in V/A/AWG	Color	Standard Pack	Catalog Number
5.2 mm	14 AWG/1.5 mm <sup>2</sup>	500/20/26–14	600/15/26–14	Gray	50	<b>XBMPKK15</b>



## Accessories

### Mini Spring Cage Terminal/Ground Blocks

Description	Color	Number of Positions	Standard Pack	XBMPK15 Catalog Number	XBMPK15PE Catalog Number	XBMPKK15 Catalog Number
End cover	Gray	—	10	XBACMPK15	XBACMPK15	XBACMPKK15
Fixed bridge	—	2	10	XBAFBR25N	—	XBAFBR25N
Separating plate	—	—	10	XBATMPKK15	—	XBATMPKK15
Blank marker strip	White	—	10	XBMZBF5 <sup>①</sup>	XBMZBF5 <sup>①</sup>	XBMZBF5 <sup>①</sup>

## Technical Data and Specifications

### Mini Spring Cage Terminal/Ground Blocks

Description	XBMPK15	XBMPK15PE	XBMPKK15
<b>Technical Data in Accordance with IEC</b>			
Maximum load current in A/cross-section in mm <sup>2</sup>	24/2.5	—	20/2.5
Rated surge voltage in kV/contamination class	8/3	8/3	6/3
Surge voltage category/insulating material group	III/1	III/1	III/1
<b>Connection Cross-Section</b>			
Stranded with ferrule with plastic sleeve in mm <sup>2</sup>	0.25–1.5	0.25–1.5	0.25–1.5
Stranded with ferrule without plastic sleeve in mm <sup>2</sup>	0.25–1.5	0.25–1.5	0.25–1.5
Stranded with twin ferrule with plastic sleeve in mm <sup>2</sup>	—	—	—
Stripping length in Inches (mm)	0.35 (9)	0.35 (9)	0.35 (9)

## Dimensions

Approximate Dimensions in Inches (mm)

### Mini Spring Cage Terminal/Ground Blocks

Catalog Number	Width	Length	Cover Length	Height for—		
				15 x 5.5 in	35 x 7.5 in	35 x 15 in
XBMPK15	0.20 (5.2)	1.57 (40.0)	0.04 (1.1)	1.36 (34.5)	—	—
XBMPK15PE	0.20 (5.2)	1.57 (40.0)	0.04 (1.1)	1.36 (34.5)	—	—
XBMPKK15	0.20 (5.2)	3.35 (85.0)	0.04 (1.1)	1.65 (42.0)	1.67 (42.5)	1.97 (50.0)

#### Notes

<sup>①</sup> For information on Printed Marking Tag Options, see **Page V7-T42-98**.

For additional accessories, see **Page V7-T42-90**.

### Pluggable Spring Cage Terminal Blocks

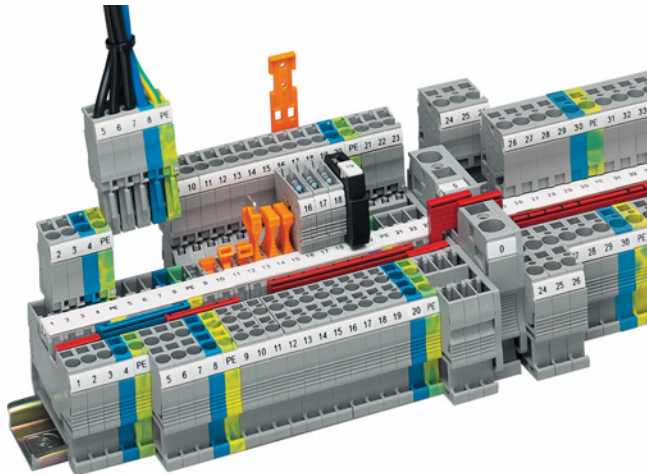

### Contents

#### Description

	<i>Page</i>
Pluggable Spring Cage Terminal Blocks	
Connection Terminal Blocks	<b>V7-T42-59</b>
Connection Plugs	<b>V7-T42-62</b>
Connection Receptacles	<b>V7-T42-64</b>
Connection Accessories	<b>V7-T42-66</b>



Drawings  
Online

### Pluggable Spring Cage Terminal Blocks Overview

#### Product Description

The pluggable spring cage connection terminal blocks allow signal and power wiring to be made pluggable. This complete pluggable system has a spring that provides maximum connection space in a space-saving design. The pluggable system accommodates stranded conductors with a nominal cross-section of 2.5 mm<sup>2</sup>, with or without ferrules.

#### Application Description

For applications requiring pluggable wiring up to a rated current of 32A and a rated voltage of 800V. The integrated overspring meets the most stringent vibration requirements. Also ideal where safety is a concern and flexibility is required. The basic terminal blocks and the plugs are finger-safe, which also means the supply voltage can be input via either the terminal blocks or the plugs. With the XBAPSC receptacles, plug-in contacts can be accommodated safely in cable ducts and distributor shafts using minimal space. A test hole can accommodate a 2.3 mm diameter test plug in each receptacle, providing a practical solution. The XBAPSP plugs are intended for connecting one wire, while the XBAPSPDB plugs are designed to connect two wires and provide an optional bridge.

#### Features

- Space-saving design
- Powerful contact
- Finger-safe



Pluggability

#### Standards and Certifications

- UL recognized—File No. E67464
- CE approved
- LVD ①:
  - EN 60947-7-1
  - EN 60947-7-2
  - EN 60998-2-3
  - EN 60352-4/A1
- ATEX approval (Eex e applications)



#### Note

① Not all standards apply to all terminal blocks. Contact Eaton for details.

**Connection Terminal Blocks**

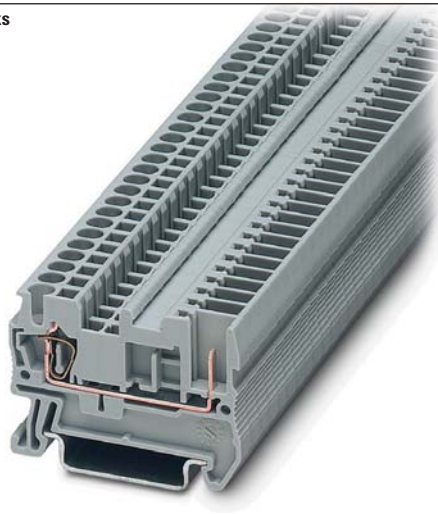

**Contents**

<b>Description</b>	<b>Page</b>
Connection Terminal Blocks	
Accessories	V7-T42-60
Technical Data and Specifications	V7-T42-60
Dimensions	V7-T42-61
Connection Plugs	V7-T42-62
Connection Receptacles	V7-T42-64
Connection Accessories	V7-T42-66

**Connection Terminal Blocks**

**Product Description**

Contact to the DIN rail is made by simply snapping the terminal block onto the rail.

These blocks act as the stationary position of the pluggable terminal blocks.

**Product Selection**

**XBPT25P**

**Pluggable Spring Cage Connection Terminal Blocks**



Terminal Width	Maximum Wire Size	IEC 61 984 in V/A/AWG	UL-cUL Ratings in V/A/AWG	Color	Standard Pack	Catalog Number
<b>Single Level</b>						
5.2 mm	12 AWG/2.5 mm <sup>2</sup>	500/24/28-12	300/20/26-12	Gray	50	<b>XBPT25P</b>
<b>Three-Wire</b>						
5.2 mm	12 AWG/2.5 mm <sup>2</sup>	500/24/28-12	300/20/26-12	Gray	50	<b>XBPT25PD12</b>

#### Accessories

#### Pluggable Spring Cage Connection Terminal Blocks

Description	Color	Number of Positions	Standard Pack	XBPT25P Catalog Number	XBPT25PD12 Catalog Number
End cover	Gray	—	10	<b>XBACPT25</b>	<b>XBACPT25D12</b>
End cover segment	Gray	—	10	—	<b>XBASPT25</b>
Partition plate	—	—	10	<b>XBATPT4</b>	<b>XBATPTD12</b>
Plug-in bridge—for cross connections in the terminal center	Red	2	10	<b>XBAFBS25</b>	<b>XBAFBS25</b>
		3	10	<b>XBAFBS35</b>	<b>XBAFBS35</b>
		5	10	<b>XBAFBS55</b>	<b>XBAFBS55</b>
		10	10	<b>XBAFBS105</b>	<b>XBAFBS105</b>
		50	10	<b>XBAFBS505</b>	<b>XBAFBS505</b>
Test adapter	—	—	10	<b>XBATSPA14</b>	<b>XBATSPA14</b>
2.3 mm diameter test plug	—	—	—	<b>XBATSMPS-<sup>①</sup></b>	<b>XBATSMPS-<sup>①</sup></b>
Modular test plug	—	—	10	<b>XBATSPS5</b>	<b>XBATSPS5</b>
Blank marker strip external labeling	White	—	10	<b>XBMZBF5<sup>②</sup></b>	<b>XBMZBF5<sup>②</sup></b>
Blank marker strip center labeling (strip of 10)	White	—	10	<b>XBMZB5<sup>②</sup></b>	<b>XBMZB5<sup>②</sup></b>

#### Technical Data and Specifications

#### Pluggable Spring Cage Connection Terminal Blocks

Description	XBPT25P	XBPT25PD12
<b>Technical Data in Accordance with IEC</b>		
Maximum load current in A/cross-section in mm <sup>2</sup>	24/4	24/4
Rated surge voltage in kV/contamination class	6/3	6/3
Surge voltage category/insulating material group	III/1	III/1
<b>Connection Capacity</b>		
Stranded with ferrule with plastic sleeve in mm <sup>2</sup>	0.25–2.5	0.25–2.5
Stranded with ferrules without plastic sleeve in mm <sup>2</sup>	0.25–2.5	0.25–2.5
Stranded with twin ferrule with plastic sleeve in mm <sup>2</sup>	0.5	0.5
Stripping length in inches (mm)	0.39 (10)	0.39 (10)

#### Notes

- ① For ordering information, see **Page V7-T42-105**.
  - ② For information on Printed Marking Tag Options, see **Page V7-T42-98**.
- For additional accessories, see **Page V7-T42-90**.

**Derating Curve for Pluggable Terminal Blocks  
XBPT25P and XBPT25PD12**

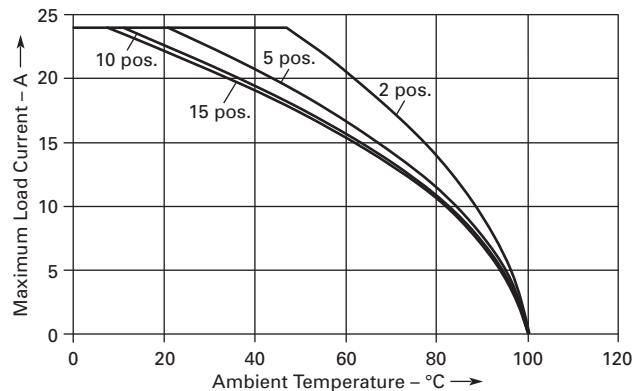

**Dimensions**

Approximate Dimensions in Inches (mm)

**Pluggable Spring Cage Connection Terminal Blocks—Without Plug**

Catalog Number	Width	Length	Cover Length	Height for—	
				35 x 7.5 in	35 x 15 in
<b>XBPT25P</b>	0.20 (5.2)	1.91 (48.5)	0.09 (2.2)	1.44 (36.5)	1.73 (44.0)
<b>XBPT25PD12</b>	0.20 (5.2)	2.38 (60.5)	0.09 (2.2)	1.44 (36.5)	1.73 (44.0)

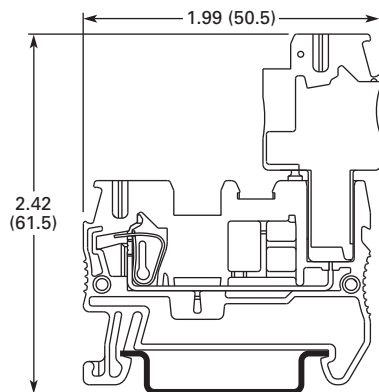
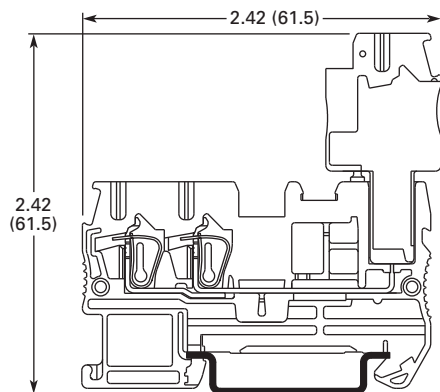
**XBPT25P****XBPT25PD12**

# 42.1

## Terminal Blocks, Fuse Blocks and Fuse Holders

IEC—XB Series

### Connection Plugs



42

### Contents

<i>Description</i>	<i>Page</i>
Connection Terminal Blocks .....	<b>V7-T42-59</b>
Connection Plugs	
Accessories .....	<b>V7-T42-63</b>
Technical Data and Specifications .....	<b>V7-T42-63</b>
Dimensions .....	<b>V7-T42-63</b>
Connection Receptacles .....	<b>V7-T42-64</b>
Connection Accessories .....	<b>V7-T42-66</b>

### Connection Plugs

#### Product Description

Just like the basic terminal blocks, the plugs also offer the perfect solution for every application. The XBAPSP25\_ plugs are designed for

connecting one conductor. The XBAPSPDB25\_ plug is designed for connecting two conductors and provides an additional bridging option.

#### Product Selection

XBAPSP25\_

#### Spring Cage Connection Plugs, Single, Not Bridgeable



Terminal Width	Maximum Wire Size	Connection Data in V/A/AWG	UL-cUL Ratings in V/A/AWG	Color	Number of Positions	Standard Pack	Catalog Number
5.2 mm	12 AWG/2.5 mm <sup>2</sup>	500/24/28–12	300/20/26–12	Gray	1	25	<b>XBAPSP251</b>
					2	25	<b>XBAPSP252</b>
					3	25	<b>XBAPSP253</b>
					4	25	<b>XBAPSP254</b>
					5	25	<b>XBAPSP255</b>
					6	25	<b>XBAPSP256</b>
					7	25	<b>XBAPSP257</b>
					8	25	<b>XBAPSP258</b>
					9	25	<b>XBAPSP259</b>
					10	25	<b>XBAPSP2510</b>
					11	10	<b>XBAPSP2511</b>
					12	10	<b>XBAPSP2512</b>

## XBAPSPDB25

## Spring Cage Connection Plugs, Double, Bridgeable



Terminal Width	Maximum Wire Size	Connection Data in V/A/AWG	UL-cUL Ratings in V/A/AWG	Color	Number of Positions	Standard Pack	Catalog Number
5.2 mm	12 AWG/2.5 mm <sup>2</sup>	500/24/28–12	300/20/26–12	Gray	1	25	<b>XBAPSPDB251</b>
					2	25	<b>XBAPSPDB252</b>
					3	25	<b>XBAPSPDB253</b>
					4	25	<b>XBAPSPDB254</b>
					5	25	<b>XBAPSPDB255</b>
					6	25	<b>XBAPSPDB256</b>
					7	25	<b>XBAPSPDB257</b>
					8	25	<b>XBAPSPDB258</b>
					9	25	<b>XBAPSPDB259</b>
					10	25	<b>XBAPSPDB2510</b>
					11	10	<b>XBAPSPDB2511</b>
					12	10	<b>XBAPSPDB2512</b>

## Accessories

## Spring Cage Connection Plugs

Description	Color	Number of Positions	Standard Pack	XBAPSP25_ Catalog Number	XBAPSPDB25_ Catalog Number
Plug-in bridge—for cross connections in the terminal center	Red	2	10	—	<b>XBAFBS25</b>
		3	10	—	<b>XBAFBS35</b>
		5	10	—	<b>XBAFBS55</b>
		10	10	—	<b>XBAFBS105</b>
Snap-lock fitting and strain relief	Orange	2	10	<b>XBAPPRZ</b>	<b>XBAPPRZ</b>
Snap-lock fitting	Orange	1	10	<b>XBAPPR</b>	<b>XBAPPR</b>
	Orange	2	10	<b>XBAPPR2</b>	<b>XBAPPR2</b>
Strain relief	Black	2	10	<b>XBAPPZ2</b>	<b>XBAPPD22</b>
	Black	4	10	<b>XBAPPZ4</b>	<b>XBAPPD24</b>
Blank marker strip	White	—	10	<b>XBMZBF5</b> ①	<b>XBMZBF5</b> ①

## Technical Data and Specifications

## Spring Cage Connection Plugs

Description	XBAPSP25_	XBAPSPDB25_
<b>Technical Data in Accordance with IEC</b>		
Maximum load current in A/cross-section in mm <sup>2</sup>	24/4	24/4
Rated surge voltage in kV/contamination class	6/3	6/3
Surge voltage category/insulating material group	III/1	III/1
<b>Connection Capacity</b>		
Stranded with ferrule with plastic sleeve in mm <sup>2</sup>	0.25–2.5	0.25–2.5
Stranded with ferrules without plastic sleeve in mm <sup>2</sup>	0.25–2.5	0.25–2.5
Stranded with twin ferrule with plastic sleeve in mm <sup>2</sup>	0.5	0.5
Stripping length in inches (mm)	0.39 (10)	0.39 (10)

## Dimensions

See **Page V7-T42-61** for dimensions.

## Notes

① For information on Printed Marking Tag Options, see **Page V7-T42-98**.

For additional accessories, see **Page V7-T42-90**.

# 42.1

## Terminal Blocks, Fuse Blocks and Fuse Holders

IEC—XB Series

### Connection Receptacles



42

### Contents

<i>Description</i>	<i>Page</i>
Connection Terminal Blocks .....	<b>V7-T42-59</b>
Connection Plugs .....	<b>V7-T42-62</b>
Connection Receptacles	
Accessories .....	<b>V7-T42-65</b>
Technical Data and Specifications .....	<b>V7-T42-65</b>
Dimensions .....	<b>V7-T42-65</b>
Connection Accessories .....	<b>V7-T42-66</b>

### Connection Receptacles

#### Product Description

With the XBAPSC25\_ Plug-in contacts can be accommodated safely in cable ducts and distributor shafts without using much

space. The standard strain reliefs can also be used. Large-surface labeling makes it possible to mark the terminal points and the entire

receptacle. A test hole can accommodate a 2.3 mm diameter test plug in each receptacle element, providing a practical solution.

#### Product Selection

XBAPSC25\_

#### Pluggable Spring Connection Receptacles



Terminal Width	Maximum Wire Size	Connection Data in V/A/AWG	UL-cUL Ratings in V/A/AWG	Color	Number of Positions	Standard Pack	Catalog Number
5.2 mm	12 AWG/2.5 mm <sup>2</sup>	500/24/28–12	300/20/26–12	Gray	2	25	<b>XBAPSC252</b>
					3	25	<b>XBAPSC253</b>
					4	25	<b>XBAPSC254</b>
					5	25	<b>XBAPSC255</b>
					6	25	<b>XBAPSC256</b>
					7	25	<b>XBAPSC257</b>
					8	25	<b>XBAPSC258</b>
					9	25	<b>XBAPSC259</b>
					10	25	<b>XBAPSC2510</b>
					11	10	<b>XBAPSC2511</b>
					12	10	<b>XBAPSC2512</b>



## Accessories

### Pluggable Spring Connection Receptacles

Description	Color	Number of Positions	Standard Pack	XBAPSC25_ Catalog Number
2.3 mm diameter test plug	Red	—	—	XBATSMPS_- <sup>①</sup>
Strain relief	Black	2	10	XBAPPDZ2
	Black	4	10	XBAPPDZ4
Blank marker strip	White	—	10	XBMZBF5 <sup>②</sup>

## Technical Data and Specifications

### Spring Cage Connection Plugs

Description	XBAPSP25_
<b>Technical Data in Accordance with IEC</b>	
Maximum load current in A/cross-section in mm <sup>2</sup>	24/4
Rated surge voltage in kV/contamination class	6/3
Surge voltage category/insulating material group	III/I
<b>Connection Capacity</b>	
Stranded with ferrule with plastic sleeve in mm <sup>2</sup>	0.25–2.5
Stranded with ferrules without plastic sleeve in mm <sup>2</sup>	0.25–2.5
Stranded with twin ferrule with plastic sleeve in mm <sup>2</sup>	0.5
Stripping length in inches (mm)	0.39 (10)

## Dimensions

Approximate Dimensions in Inches (mm)

### Spring Cage Connection Plugs

Catalog Number	Width	Length	Cover Length	Height
XBAPSP25_	0.20 (5.2)	1.46 (37.2)	0.09 (2.2)	0.71 (18.0)

### Receptacle Widths

Catalog Number	Width	Catalog Number	Width
XBAPSC252	0.41 (10.4)	XBAPSC258	1.64 (41.6)
XBAPSC253	0.61 (15.6)	XBAPSC259	1.84 (46.8)
XBAPSC254	0.82 (20.8)	XBAPSC2510	2.05 (52.0)
XBAPSC255	1.02 (26.0)	XBAPSC2511	2.25 (57.2)
XBAPSC256	1.23 (31.2)	XBAPSC2512	2.46 (62.4)
XBAPSC257	1.43 (36.4)		

#### Notes

<sup>①</sup> For ordering information, see **Page V7-T42-105**.

<sup>②</sup> For information on Printed Marking Tag Options, see **Page V7-T42-98**.

For additional accessories, see **Page V7-T42-90**.

# 42.1

## Terminal Blocks, Fuse Blocks and Fuse Holders

IEC—XB Series

### Connection Accessories

#### Product Description

The pluggable XBPT series features an extensive range of application-oriented accessories. Strain reliefs are available for the plugs and

can be snapped on at the required points as an option. The snap-lock fitting can be used for all plug variants. It is snapped into the outside of

the plug housing as an option and hooks onto the terminal block housing when the plug is snapped on.

#### Product Selection

#### Pluggable Spring Cage Connection Accessories

	Description	Number of Positions	Standard Pack	Catalog Number
<b>XBAPPZ2</b> 	Strain relief for single plugs	2	10	<b>XBAPPZ2</b>
		4	10	<b>XBAPPZ4</b>
<b>XBAPPDZ4</b> 	Strain relief for double plugs and receptacles	2	10	<b>XBAPPDZ2</b>
		4	10	<b>XBAPPDZ4</b>
<b>XBAPPR2</b> 	Snap-lock fitting for plugs	1	10	<b>XBAPPR</b>
		2	10	<b>XBAPPR2</b>
<b>XBAPPRZ</b> 	Snap-lock fitting and strain relief for plugs	2	10	<b>XBAPPRZ</b>

#### Strain Relief

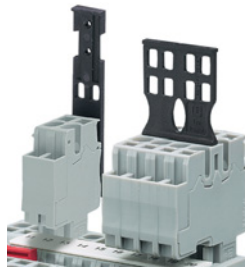

#### Snap-Lock Fitting

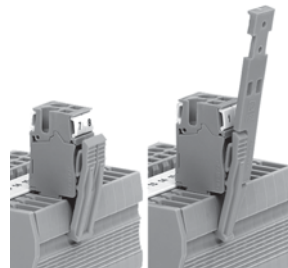

#### Optional Accessory Recommendations

Number of Positions Receptacle	Strain Relief
2–4	<b>XBAPPZ2</b>
5–10	<b>XBAPPZ4</b> or (2) <b>XBAPPZ2</b>
11–15	(2) <b>XBAPPZ4</b> or (4) <b>XBAPPZ2</b>

## IDC Terminal Blocks



## Contents

## Description

## Page

IDC Terminal Blocks	
Single Level	V7-T42-68
Multi-Conductor	V7-T42-70
Double Level	V7-T42-73
Fuse Terminal Blocks	V7-T42-75
Disconnect and Component Terminal Blocks	V7-T42-77
Hybrid Terminal Blocks	V7-T42-79

Drawings  
Online

## IDC (Insulation Displacement Connection) Terminal Blocks Overview

## Product Description

The superior design of Eaton's Insulation Displacement Connection (IDC) technology terminal blocks reduces wiring installation time and labor, especially in high-volume applications. IDC terminal blocks are suited for applications in automated equipment and machine tools, packaging and material handling machinery, railway/mass transit systems, petrochemical, and any other application requiring high-volume connections for low-voltage control and signal circuitry where labor cost reduction and ease of assembly is desired. These terminal blocks are designed for long-term use under demanding conditions.

The XBQT Series allows for wire to be connected without any prior stripping. The quick connection provides up to 60% reduction in wiring time. One turn of a standard screwdriver results in a simple, fast and reliable connection.

## Application Description

The XBQT is operated with a standard screwdriver. The switching states are clearly signaled by engagement points in the start and end positions. Solid and stranded wires of 0.25 to 2.5 mm<sup>2</sup> can be wired without the use of ferrules. Stripping the wire is not required—the wire's insulation is cut open when it is properly connected. The wire is securely placed in the end position where it makes large-area, gas-tight contact. Connections are made in seconds!

## Features

- Quick connection capability
- Global acceptance
- Flexible plug-in bridge system
- Large surface area for marking
- Standardized testing system

## Standards and Certifications

- UL recognized—File No. E67464
- CE approved
- LVD <sup>①</sup>
  - EN 60947-7-1
  - EN 60947-7-2
  - EN 60998-2-3
  - EN 60352-4/A1
- ATEX approval (Eex e applications)



## Note

- <sup>①</sup> Not all standards apply to all terminal blocks. Contact Eaton for details.

Single Level



### Contents

Description	Page
Single Level	
Accessories	V7-T42-69
Technical Data and Specifications	V7-T42-69
Dimensions	V7-T42-69
Multi-Conductor	V7-T42-70
Double Level	V7-T42-73
Fuse Terminal Blocks	V7-T42-75
Disconnect and Component Terminal Blocks	V7-T42-77
Hybrid Terminal Blocks	V7-T42-79

### Single Level

#### Product Description

The XBQT IDC terminal block has the fastest connection time in a compact design. The space-saving front connection design offers additional space for wiring between the cable ducts. The double bridge shaft can

accommodate individual chain bridging and step-down bridging from other terminal blocks. The XBQT ground blocks are the same shape as the feed-through terminal blocks with the same wide range of cross-sections

available. They easily snap onto the DIN rail to make a reliable mechanical and electrical contact that meets all requirements of IEC 60-947-7-2.

#### Product Selection

XBQT25



#### IDC—Single Level Terminal Blocks

Terminal Width	Maximum Wire Size	Connection Data in V/A/AWG	EN 50 019 ① in V/A/AWG	UL-cUL Ratings in V/A/AWG	Color	Standard Pack	Catalog Number
5.2 mm	16 AWG/1.5 mm <sup>2</sup>	800/17.5/24–16	550/16/24–16	600/10/24–16	Gray	50	XBQT15
					Blue	50	XBQT15BU
6.2 mm	14 AWG/2.5 mm <sup>2</sup>	800/24/20–14	—	600/15/20–14	Gray	50	XBQT25
					Blue	50	XBQT25BU

XBQT15PE



#### IDC—Single Level Terminal Ground Blocks

Terminal Width	Maximum Wire Size	Connection Data in V/A/AWG	EN 50 019 ① in V/A/AWG	UL-cUL Ratings in V/A/AWG	Color	Standard Pack	Catalog Number
5.2 mm	16 AWG/1.5 mm <sup>2</sup>	—/—/24–16	—/—/24–16	—/—/24–16	Green/Yellow	50	XBQT15PE
6.2 mm	14 AWG/2.5 mm <sup>2</sup>	—/—/20–14	—	—/—/20–14	Green/Yellow	50	XBQT25PE

#### Note

① EU type—examination certificate number: KEMA 05ATEX2157 U (XBQT15), KEMA 05ATEX2160 U (XBQT25).

## Accessories

## IDC—Single Level Terminal/Ground Blocks

Description	Color	Number of Positions	Standard Pack	XBQT15 Catalog Number	XBQT25 Catalog Number	XBQT15PE Catalog Number	XBQT25PE Catalog Number
End cover	Gray	—	10	<b>XBACQT15</b>	<b>XBACQT25</b>	<b>XBACQT15</b>	<b>XBACQT25</b>
Partition plate	—	—	10	<b>XBATQT25</b>	<b>XBATQT25</b>	<b>XBATQT25</b>	<b>XBATQT25</b>
Plug-in bridge	Red	2	10	<b>XBAFBS25</b>	<b>XBAFBS26</b>	<b>XBAFBS25</b>	<b>XBAFBS26</b>
		3	10	<b>XBAFBS35</b>	<b>XBAFBS36</b>	<b>XBAFBS35</b>	<b>XBAFBS36</b>
		5	10	<b>XBAFBS55</b>	<b>XBAFBS56</b>	<b>XBAFBS55</b>	<b>XBAFBS56</b>
		10	10	<b>XBAFBS105</b>	<b>XBAFBS106</b>	<b>XBAFBS105</b>	<b>XBAFBS106</b>
		50	10	<b>XBAFBS505</b>	<b>XBAFBS506</b>	<b>XBAFBS505</b>	<b>XBAFBS506</b>
Test adapter	—	—	10	<b>XBATSPA14</b>	<b>XBATSPA14</b>	<b>XBATSPA14</b>	<b>XBATSPA14</b>
2.3 mm diameter test plug	—	—	—	<b>XBATSMPS-<sup>①</sup></b>	<b>XBATSMPS-<sup>①</sup></b>	<b>XBATSMPS-<sup>①</sup></b>	<b>XBATSMPS-<sup>①</sup></b>
Modular test plug	—	—	10	<b>XBATSPS5</b>	<b>XBATSPS6</b>	<b>XBATSPS5</b>	<b>XBATSPS6</b>
Blank marker strip center and external marking	White	—	10	<b>XBMZBF5<sup>②</sup></b>	<b>XBMZBF6<sup>②</sup></b>	<b>XBMZBF5<sup>②</sup></b>	<b>XBMZBF6<sup>②</sup></b>
Blank marker strip center labeling (strip of 10)	White	—	10	<b>XBMZB5<sup>②</sup></b>	<b>XBMZB6<sup>②</sup></b>	<b>XBMZB5<sup>②</sup></b>	<b>XBMZB6<sup>②</sup></b>

## Technical Data and Specifications

## IDC—Single Level Terminal/Ground Blocks

Description	XBQT15	XBQT25	XBQT15PE	XBQT25PE
<b>Technical Data in Accordance with IEC</b>				
Maximum load current in A/cross-section in mm <sup>2</sup>	17.5/1.5	24/2.5	—	—
Rated surge voltage in kV/contamination class	8/3	8/3	8/3	8/3
Surge voltage category/insulating material group	III/1	III/1	III/1	III/1
<b>Connection Cross-Section</b>				
Core insulation	PVC/PE	PVC/PE	PVC/PE	PVC/PE
Single/multiple/fine strand in mm <sup>2</sup>	1.5	2.5	1.5	2.5
Halogen-free in mm <sup>2</sup>	1.5	2.5	1.5	2.5
Fine strand/superfine strand in AWG (mm <sup>2</sup> )	24–16 (0.25–0.34)	20–14 (—)	24–16 (0.25–0.34)	20–14 (—)
Repeated connections minimum 100 x in mm <sup>2</sup>	0.25–1.5	0.5–2.5	0.25–1.5	0.5–2.5

## Dimensions

Approximate Dimensions in Inches (mm)

## IDC—Single Level Terminal/Ground Blocks

Catalog Number	Width	Length	Cover Length	Height for—	
				35 x 7.5 in	35 x 15 in
<b>XBQT15</b>	0.20 (5.2)	2.31 (58.8)	0.09 (2.2)	1.55 (39.3)	1.84 (46.8)
<b>XBQT25</b>	0.24 (6.2)	2.46 (62.6)	0.09 (2.2)	1.55 (39.3)	1.84 (46.8)
<b>XBQT15PE</b>	0.20 (5.2)	2.31 (58.8)	0.09 (2.2)	1.55 (39.3)	1.84 (46.8)
<b>XBQT25PE</b>	0.24 (6.2)	2.46 (62.6)	0.09 (2.2)	1.55 (39.3)	1.84 (46.8)

## Notes

- ① For ordering information, see **Page V7-T42-105**.  
 ② For information on Printed Marking Tag Options, see **Page V7-T42-98**.  
 For additional accessories, see **Page V7-T42-90**.

#### Multi-Conductor



#### Contents

Description	Page
Single Level	V7-T42-68
Multi-Conductor	
Accessories	V7-T42-71
Technical Data and Specifications	V7-T42-72
Dimensions	V7-T42-72
Double Level	V7-T42-73
Fuse Terminal Blocks	V7-T42-75
Disconnect and Component Terminal Blocks	V7-T42-77
Hybrid Terminal Blocks	V7-T42-79

### Multi-Conductor

#### Product Description

The XBQT IDC terminal block has the fastest connection time in a compact design. The space-saving front connection design offers additional space for wiring between the cable ducts. The double bridge shaft can

accommodate individual chain bridging and step-down bridging from other terminal blocks. The XBQT ground blocks are the same shape as the feed-through terminal blocks with the same wide range of cross-sections

available. They easily snap onto the DIN rail to make a reliable mechanical and electrical contact that meets all requirements of IEC 60-947-7-2.

#### Product Selection

##### XBQT25D12



#### IDC—Multi-Conductor Terminal Blocks, Three-Wire

Terminal Width	Maximum Wire Size	Connection Data in V/A/AWG	EN 50 019 ① in V/A/AWG	UL-cUL Ratings in V/A/AWG	Color	Standard Pack	Catalog Number
5.2 mm	16 AWG/1.5 mm <sup>2</sup>	800/17.5/24–16	550/16/24–16	600/10/24–16	Gray	50	XBQT15D12
					Blue	50	XBQT15D12BU
6.2 mm	14 AWG/2.5 mm <sup>2</sup>	800/24/20–14	—	600/15/20–14	Gray	50	XBQT25D12
					Blue	50	XBQT25D12BU

##### XBQT15D22PE



#### IDC—Multi-Conductor Terminal Blocks, Four-Wire

Terminal Width	Maximum Wire Size	Connection Data in V/A/AWG	EN 50 019 ① in V/A/AWG	UL-cUL Ratings in V/A/AWG	Color	Standard Pack	Catalog Number
5.2 mm	16 AWG/1.5 mm <sup>2</sup>	800/17.5/24–16	550/16/24–16	600/10/24–16	Gray	50	XBQT15D22
					Blue	50	XBQT15D22BU

#### IDC—Multi-Conductor Terminal Blocks, Four-Wire Ground Blocks

Terminal Width	Maximum Wire Size	Connection Data in V/A/AWG	EN 50 019 ① in V/A/AWG	UL-cUL Ratings in V/A/AWG	Color	Standard Pack	Catalog Number
5.2 mm	16 AWG/1.5 mm <sup>2</sup>	—/—/24–16	—/—/24–16	—/—/24–16	Green/Yellow	50	XBQT15D22PE

#### Note

① EU type—examination certificate number: KEMA 05ATEX2157 U (XBQT15), KEMA 05ATEX2160 U (XBQT25).

## XBQT15D12PE



## IDC—Multi-Conductor Terminal Blocks, Three-Wire Ground Blocks

Terminal Width	Maximum Wire Size	Connection Data in V/A/AWG	EN 50 019 <sup>①</sup> in V/A/AWG	UL-cUL Ratings in V/A/AWG	Color	Standard Pack	Catalog Number
5.2 mm	16 AWG/1.5 mm <sup>2</sup>	—/—/24–16	—/—/24–16	—/—/24–16	Green/Yellow	50	XBQT15D12PE
6.2 mm	14 AWG/2.5 mm <sup>2</sup>	—/—/20–14	—	—/—/20–14	Green/Yellow	50	XBQT25D12PE

## Accessories

## IDC—Multi-Conductor Terminal Blocks

Description	Color	Number of Positions	Standard Pack	XBQT15D12 Catalog Number	XBQT25D12 Catalog Number	XBQT15D22 Catalog Number
End cover	Gray	—	10	XBACQT15D12	XBACQT25D12	XBACQT15D22
End cover segment	Gray	—	10	XBASQT15	XBASQT25	XBASQT15
Partition plate	—	—	10	XBATQTD12	XBATQTD12	XBATQTD22
Plug-in bridge—for cross connections in the terminal center	Red	2	10	XBAFBS25	XBAFBS26	XBAFBS25
		3	10	XBAFBS35	XBAFBS36	XBAFBS35
		5	10	XBAFBS55	XBAFBS56	XBAFBS55
		10	10	XBAFBS105	XBAFBS106	XBAFBS105
		50	10	XBAFBS505	XBAFBS506	XBAFBS505
Test adapter	—	—	10	XBATSPA14	XBATSPA14	XBATSPA14
2.3 mm diameter test plug	—	—	—	XBATSMPS- <sup>②</sup>	XBATSMPS- <sup>②</sup>	XBATSMPS- <sup>②</sup>
Modular test plug	—	—	10	XBATSPS5	XBATSPS6	XBATSPS5
Blank marker strip center and external marking	White	—	10	XBMZBF5 <sup>③</sup>	XBMZBF6 <sup>③</sup>	XBMZBF5 <sup>③</sup>
Blank marker strip center labeling (strip of 10)	White	—	10	XBMZB5 <sup>③</sup>	XBMZB6 <sup>③</sup>	XBMZB5 <sup>③</sup>

## IDC—Multi-Conductor Terminal/Ground Blocks

Description	Color	Number of Positions	Standard Pack	XBQT15D12PE Catalog Number	XBQT25D12PE Catalog Number	XBQT15D22PE Catalog Number
End cover	Gray	—	10	XBACQT15D12	XBACQT25D12	XBACQT15D22
End cover segment	Gray	—	10	XBASQT15	XBASQT25	XBASQT15
Partition plate	—	—	10	XBATQTD12	XBATQTD12	XBATQTD22
Plug-in bridge—for cross connections in the terminal center	Red	2	10	XBAFBS25	XBAFBS26	XBAFBS25
		3	10	XBAFBS35	XBAFBS36	XBAFBS35
		5	10	XBAFBS55	XBAFBS56	XBAFBS55
		10	10	XBAFBS105	XBAFBS106	XBAFBS105
		50	10	XBAFBS505	XBAFBS506	XBAFBS505
Test adapter	—	—	10	XBATSPA14	XBATSPA14	XBATSPA14
2.3 mm diameter test plug	—	—	—	XBATSMPS- <sup>②</sup>	XBATSMPS- <sup>②</sup>	XBATSMPS- <sup>②</sup>
Modular test plug	—	—	10	XBATSPS5	XBATSPS6	XBATSPS5
Blank marker strip center and external marking	White	—	10	XBMZBF5 <sup>③</sup>	XBMZBF6 <sup>③</sup>	XBMZBF5 <sup>③</sup>
Blank marker strip center labeling (strip of 10)	White	—	10	XBMZB5 <sup>③</sup>	XBMZB6 <sup>③</sup>	XBMZB5 <sup>③</sup>

## Notes

<sup>①</sup> EU type—examination certificate number: KEMA 05ATEX2157 U (XBQT15PE), KEMA 05ATEX2160 U (XBQT25PE).

<sup>②</sup> For ordering information, see [Page V7-T42-105](#).

<sup>③</sup> For information on Printed Marking Tag Options, see [Page V7-T42-98](#).

For additional accessories, see [Page V7-T42-90](#).

## Technical Data and Specifications

### IDC—Multi-Conductor Terminal Blocks

Description	XBQT15D12	XBQT25D12	XBQT15D12PE	XBQT25D12PE	XBQT15D22	XBQT15D22PE
<b>Technical Data in Accordance with IEC</b>						
Maximum load current in A/cross-section in mm <sup>2</sup>	17.5/1.5	24/2.5	—	—	17.5/1.5	—
Rated surge voltage in kV/contamination class	8/3	8/3	8/3	8/3	8/3	8/3
Surge voltage category/insulating material group	III/I	III/I	III/I	III/I	III/I	III/I
<b>Connection Cross-Section</b>						
Core insulation	PVC/PE	PVC/PE	PVC/PE	PVC/PE	PVC/PE	PVC/PE
Single/multiple/fine strand in mm <sup>2</sup>	1.5	2.5	1.5	2.5	1.5	1.5
Halogen-free in mm <sup>2</sup>	1.5	2.5	1.5	2.5	1.5	1.5
Fine strand/superfine strand in AWG (mm <sup>2</sup> )	24–16 (0.25–0.34)	20–14 (—)	24–16 (0.25–0.34)	20–14 (—)	24–16 (0.25–0.34)	24–16 (0.25–0.34)
Repeated connections minimum 100 x in mm <sup>2</sup>	0.25–1.5	0.5–2.5	0.25–1.5	0.5–2.5	0.25–1.5	0.25–1.5

## Dimensions

Approximate Dimensions in Inches (mm)

### IDC—Multi-Conductor Terminal Blocks

Catalog Number	Width	Length	Cover Length	Height for—	
				35 x 7.5 in	35 x 15 in
XBQT15D12	0.20 (5.2)	3.01 (76.4)	0.09 (2.2)	1.55 (39.3)	1.84 (46.8)
XBQT25D12	0.24 (6.2)	3.25 (82.5)	0.09 (2.2)	1.69 (42.8)	1.98 (50.3)
XBQT15D12PE	0.20 (5.2)	3.01 (76.4)	0.09 (2.2)	1.55 (39.3)	1.84 (46.8)
XBQT25D12PE	0.20 (5.2)	3.25 (82.5)	0.09 (2.2)	1.69 (42.8)	1.98 (50.3)
XBQT15D22	0.20 (5.2)	3.70 (94.0)	0.09 (2.2)	1.55 (39.3)	1.84 (46.8)
XBQT15D22PE	0.20 (5.2)	3.70 (94.0)	0.09 (2.2)	1.55 (39.3)	1.84 (46.8)



## Double Level

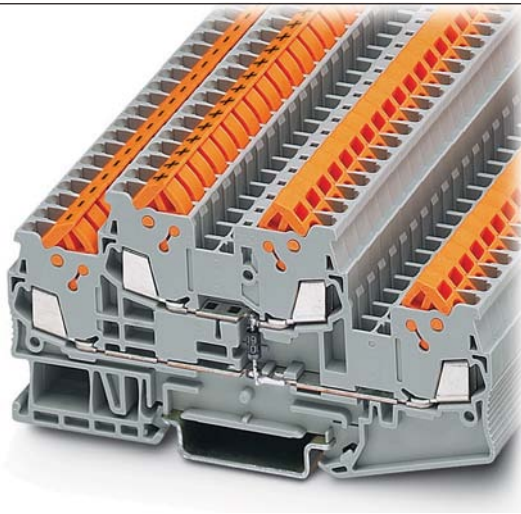

## Contents

Description	Page
Single Level . . . . .	V7-T42-68
Multi-Conductor . . . . .	V7-T42-70
Double Level	
Accessories . . . . .	V7-T42-74
Technical Data and Specifications . . . . .	V7-T42-74
Dimensions . . . . .	V7-T42-74
Fuse Terminal Blocks . . . . .	V7-T42-75
Disconnect and Component Terminal Blocks . . . . .	V7-T42-77
Hybrid Terminal Blocks . . . . .	V7-T42-79

## Double Level

## Product Description

The XBQTT IDC terminal block has the fastest connection time in a compact design. The space-saving front connection design offers additional space for wiring between the cable ducts. The double bridge

shaft, found in each level, can accommodate individual chain bridging and step-down bridging from other terminal blocks. The XBQTT ground blocks are the same shape as the feed-through terminal blocks with the same wide

range of cross-sections available. They easily snap onto the DIN rail to make a reliable mechanical and electrical contact that meets all requirements of IEC 60-947-7-2.

## Product Selection

## XBQTT15



## IDC—Double Level Terminal Blocks

Terminal Width	Maximum Wire Size	Connection Data in V/A/AWG	EN 50 019 ① in V/A/AWG	UL-cUL Ratings in V/A/AWG	Color	Standard Pack	Catalog Number
5.2 mm	16 AWG/1.5 mm <sup>2</sup>	800/17.5/24–16	420/15/24–16	600/10/24–16	Gray	50	XBQTT15
					Blue	50	XBQTT15BU

## XBQTT15PE



## IDC—Double Level Ground Blocks

Terminal Width	Maximum Wire Size	Connection Data in V/A/AWG	EN 50 019 ① in V/A/AWG	UL-cUL Ratings in V/A/AWG	Color	Standard Pack	Catalog Number
6.2 mm	14 AWG/2.5 mm <sup>2</sup>	—/—/24–16	—/—/24–16	—/—/24–16	Green/Yellow	50	XBQTT15PE

## Note

① EU type—examination certificate number: KEMA 05ATEX2157 U (XBQTT15), KEMA 05ATEX2160 U (XBQTT25).

#### Accessories

##### IDC—Double Level Terminal/Ground Blocks

Description	Color	Number of Positions	Standard Pack	XBQTT15 Catalog Number	XBQTT15PE Catalog Number
End cover	Gray	—	10	XBACQTT15	XBACQTT15
Partition plate	—	—	10	XBATQTT15	XBATQTT15
Plug-in bridge—for cross connections in the terminal center	Red	2	10	XBAFBS25	XBAFBS25
		3	10	XBAFBS35	XBAFBS35
		5	10	XBAFBS55	XBAFBS55
		10	10	XBAFBS105	XBAFBS105
		20	10	XBAFBS505	XBAFBS505
Test adapter	—	—	10	XBATSPA14	XBATSPA14
2.3 mm diameter test plug	—	—	—	XBATSMPS- <sup>①</sup>	XBATSMPS- <sup>①</sup>
Modular test plug	—	—	10	XBATSPS5	XBATSPS5
Blank marker strip	White	—	10	XBMZBF5 <sup>②</sup>	XBMZBF5 <sup>②</sup>

#### Technical Data and Specifications

##### IDC—Double Level Terminal/Ground Blocks

Description	XBQTT15	XBQTT15PE
<b>Technical Data in Accordance with IEC</b>		
Maximum load current in A/cross-section in mm <sup>2</sup>	17.5/1.5	—
Rated surge voltage in kV/contamination class	6/3	6/3
Surge voltage category/insulating material group	III/I	III/I
<b>Connection Cross-Section</b>		
Core insulation	PVC/PE	PVC/PE
Single/multiple/fine strand in mm <sup>2</sup>	1.5	1.5
Halogen-free in mm <sup>2</sup>	1.5	1.5
Fine strand/superfine strand in AWG (mm <sup>2</sup> )	24–16 (0.25–0.34)	24–16 (0.25–0.34)
Repeated connections minimum 100 x in mm <sup>2</sup>	0.25–1.5	0.25–1.5

#### Dimensions

Approximate Dimensions in Inches (mm)

##### IDC—Double Level Terminal/Ground Blocks

Catalog Number	Width	Length	Cover Length	Height for—	
				35 x 7.5 in	35 x 15 in
XBQTT15	0.20 (5.2)	3.92 (99.6)	0.09 (2.2)	1.96 (49.9)	2.26 (57.4)
XBQTT15PE	0.20 (5.2)	3.92 (99.6)	0.09 (2.2)	1.96 (49.9)	2.26 (57.4)

#### Notes

- ① For ordering information, see [Page V7-T42-105](#).
  - ② For information on Printed Marking Tag Options, see [Page V7-T42-98](#).
- For additional accessories, see [Page V7-T42-90](#).

## Fuse Terminal Blocks



## Contents

<b>Description</b>	<b>Page</b>
Single Level . . . . .	V7-T42-68
Multi-Conductor . . . . .	V7-T42-70
Double Level . . . . .	V7-T42-73
Fuse Terminal Blocks	
Accessories . . . . .	V7-T42-76
Technical Data and Specifications . . . . .	V7-T42-76
Dimensions . . . . .	V7-T42-76
Disconnect and Component Terminal Blocks . . . . .	V7-T42-77
Hybrid Terminal Blocks . . . . .	V7-T42-79

## Fuse Terminal Blocks

## Product Description

The XBQT lever-type fuse terminal blocks perform two main functions. It is a carrier for a 5 x 20 mm cartridge fuse insert and can also allow for potential distribution via the double bridge shaft.

This means that two potentials can be carried separately alongside each other. Versions with light indication (AC and DC voltage) are available to signal a triggered fuse.

## Product Selection

## XBQT25FB



## IDC—Fuse Terminal Blocks

Terminal Width	Maximum Wire Size	Connection Data in V/A/AWG	UL-cUL Ratings in V/A/AWG	Color	Standard Pack	Catalog Number
<b>IDC Fuse Terminal Blocks</b>						
6.2 mm	14 AWG/2.5 mm <sup>2</sup>	①/6.3/20–14	300/15/20–14	Black	50	<b>XBQT25FBE</b>
<b>IDC Fuse Terminal Blocks with LED 12–30V, 1–2.5 mA</b>						
6.2 mm	14 AWG/2.5 mm <sup>2</sup>	①/6.3/20–14	300/15/20–14	Black	50	<b>XBQT25FBEL24</b>
<b>IDC Fuse Terminal Blocks with LED 30–60V, 0.8–2.0 mA</b>						
6.2 mm	14 AWG/2.5 mm <sup>2</sup>	①/6.3/20–14	300/15/20–14	Black	50	<b>XBQT25FBEL60</b>
<b>IDC Fuse Terminal Blocks with LED 110–250V, 0.5–2.5 mA</b>						
6.2 mm	14 AWG/2.5 mm <sup>2</sup>	①/6.3/20–14	300/15/20–14	Black	50	<b>XBQT25FBEL250</b>

**Note**

① As disconnect terminal block, 400V; as fuse terminal blocks 250V.

## Accessories

## IDC—Fuse Terminal Blocks

Description	Color	Number of Positions	Standard Pack	XBQT25FBE
				Catalog Number
End cover	Gray	—	10	<b>XBACQT25D12</b>
Partition plate	—	—	10	<b>XBATQTD12</b>
Plug-in bridge—for cross connections in the terminal center	Red	2	10	<b>XBAFBS26</b>
		3	10	<b>XBAFBS36</b>
		5	10	<b>XBAFBS56</b>
		10	10	<b>XBAFBS106</b>
Test adapter	—	—	10	<b>XBATSPA14</b>
2.3 mm diameter test plug	—	—	—	<b>XBATSMPS-</b> <sup>①</sup>
Modular test plug	—	—	10	<b>XBATSPS5</b>
Blank marker strip center and external marking	White	—	10	<b>XBMZBF6</b> <sup>②</sup>
Blank marker strip lever labeling	White	—	10	<b>XBMZB5</b> <sup>②</sup>
Blank marker strip center labeling (strip of 10)	White	—	10	<b>XBMZB6</b> <sup>②</sup>

## Technical Data and Specifications

## IDC—Fuse Terminal Blocks

Description	XBQT25FBE
<b>Technical Data in Accordance with IEC</b>	
Maximum load current in A/cross-section in mm <sup>2</sup>	6.3/2.5
Rated surge voltage in kV/contamination class	4/3
Surge voltage category/insulating material group	III/I
<b>Connection Cross-Section</b>	
Core insulation	PVC/PE
Single/multiple/fine strand in mm <sup>2</sup>	2.5
Halogen-free in mm <sup>2</sup>	2.5
Fine strand/superfine strand in AWG (mm <sup>2</sup> )	24–14 (—)
Repeated connections minimum 100 x in mm <sup>2</sup>	0.5–2.5

## Dimensions

Approximate Dimensions in Inches (mm)

## IDC—Fuse Terminal Blocks

Catalog Number	Width	Length	Cover Length	Height for—	
				35 x 7.5 in	35 x 15 in
<b>XBQT25FBE</b>	0.24 (6.2)	3.25 (82.5)	0.09 (2.2)	1.69 (42.8)	1.98 (50.3)

## Notes

<sup>①</sup> For ordering information, see **Page V7-T42-105**.

<sup>②</sup> For information on Printed Marking Tag Options, see **Page V7-T42-98**.

For additional accessories, see **Page V7-T42-90**.

## Disconnect and Component Terminal Blocks



## Contents

Description	Page
Single Level . . . . .	V7-T42-68
Multi-Conductor . . . . .	V7-T42-70
Double Level . . . . .	V7-T42-73
Fuse Terminal Blocks . . . . .	V7-T42-75
Disconnect and Component Terminal Blocks	
Accessories . . . . .	V7-T42-78
Technical Data and Specifications . . . . .	V7-T42-78
Dimensions . . . . .	V7-T42-78
Hybrid Terminal Blocks . . . . .	V7-T42-79

## Disconnect and Component Terminal Blocks

## Product Description

The **XB** Series includes application specific terminal blocks like disconnect blocks. The knife disconnect terminal blocks (XBQT15MT) has a fitted knife. The XBQT15TG

can accommodate component plugs for resistors or capacitors and fuse plugs for 5 x 20 mm fuses with or without a light indicator for signaling a triggered fuse.

Both terminal blocks have three bridge shafts—two in the standard positions and one on the other side of the disconnect point.

## Product Selection

XBQT15MT  
Knife Disconnect

## IDC—Disconnect and Component Terminal Blocks

Terminal Width	Maximum Wire Size	Connection Data in V/A/AWG	UL-cUL Ratings in V/A/AWG	UL-cUL Ratings for Disconnect in V/A/AWG	UL-cUL Ratings for Disconnect with Test Sockets in V/A/AWG	Color	Standard Pack	Catalog Number
<b>Knife Disconnect</b>								
5.2 mm	16 AWG/1.5 mm <sup>2</sup>	400/16/24–16	600/10/24–16	—	—	Gray	50	<b>XBQT15MT</b>
<b>Component Disconnect</b>								
5.2 mm	16 AWG/1.5 mm <sup>2</sup>	400/16/24–16	600/10/24–16	—	—	Gray	50	<b>XBQT15TG</b>
6.2 mm	14 AWG/2.5 mm <sup>2</sup>	400/16/20–14	300/10/20–14	—	—	Gray	50	<b>XBQT25TG</b>
<b>Component Plug</b>								
6.2 mm	10 AWG/4 mm <sup>2</sup>	500/16/26–10	—	600/16/26–10	300/16/26–10	Gray	10	<b>XBPCO</b>
<b>Fuse Plug</b>								
6.2 mm	10 AWG/4 mm <sup>2</sup>	500/16/26–10	—	600/16/26–10	300/16/26–10	Black	10	<b>XBPFU</b>
<b>Fuse Plug with Light Indicator for 12–30V, 1–2.5 mA</b>								
6.2 mm	10 AWG/4 mm <sup>2</sup>	500/16/26–10	—	600/16/26–10	300/16/26–10	Black	10	<b>XBPFUL24</b>
<b>Fuse Plug with Light Indicator for 110–250V, 0.5–2.5 mA</b>								
6.2 mm	10 AWG/4 mm <sup>2</sup>	500/16/26–10	—	600/16/26–10	300/16/26–10	Black	10	<b>XBPFUL250</b>

## Accessories

## IDC—Disconnect and Component Terminal Blocks

Description	Color	Number of Positions	Standard Pack	XBQT15MT Catalog Number	XBQT15TG Catalog Number	XBQT25TG Catalog Number
End cover	Gray	—	10	XBACQT15D12	XBACQT15D12	XBACQT25D12
End cover segment	Gray	—	10	XBASQT15	XBASQT15	XBASQT25
Partition plate	—	—	10	XBATQTD12	XBATQTD12	XBATQTD12
Plug-in bridge	Red	2	10	XBAFBS25	XBAFBS25	XBAFBS26
		3	10	XBAFBS35	XBAFBS35	XBAFBS36
		5	10	XBAFBS55	XBAFBS55	XBAFBS56
		10	10	XBAFBS105	XBAFBS105	XBAFBS106
Test adapter	—	—	10	XBATSPA14	XBATSPA14	XBATSPA14
2.3 mm diameter test plug	—	—	—	XBATSMPS_ <sup>①</sup>	XBATSMPS_ <sup>①</sup>	XBATSMPS_ <sup>①</sup>
Modular test plug	—	—	10	XBATSPS5	XBATSPS5	XBATSPS5
Blank marker strip center and external marking	White	—	10	XBMZBF5 <sup>②</sup>	XBMZBF5 <sup>②</sup>	XBMZBF6 <sup>②</sup>
Blank marker strip center labeling (strip of 10)	White	—	10	XBMZB5 <sup>②</sup>	XBMZB5 <sup>②</sup>	XBMZB6 <sup>②</sup>

## Technical Data and Specifications

## IDC—Disconnect and Component Terminal Blocks

Description	XBQT15MT	XBQT15TG	XBQT25TG
<b>Technical Data in Accordance with IEC</b>			
Maximum load current in A/cross-section in mm <sup>2</sup>	16/1.5	16/1.5	16/2.5
Rated surge voltage in kV/contamination class	6/3	6/3	6/3
Surge voltage category/insulating material group	III/I	III/I	III/I
<b>Connection Cross-Section</b>			
Core insulation	PVC/PE	PVC/PE	PVC/PE
Single/multiple/fine strand in mm <sup>2</sup>	1.5	1.5	2.5
Halogen-free in mm <sup>2</sup>	1.5	1.5	2.5
Fine strand/superfine strand in AWG (mm <sup>2</sup> )	24–16 (0.25–0.34)	24–16 (0.25–0.34)	20–14 (—)
Repeated connections minimum 100 x in mm <sup>2</sup>	0.25–1.5	0.25–1.5	0.5–2.5

## Dimensions

Approximate Dimensions in Inches (mm)

## IDC—Disconnect and Component Terminal Blocks

Catalog Number	Width	Length	Cover Length	Height for—	
				35 x 7.5 in	35 x 15 in
XBQT15MT	0.20 (5.2)	3.01 (76.4)	0.09 (2.2)	1.55 (39.3)	1.84 (46.8)
XBQT15TG	0.20 (5.2)	3.01 (76.4)	0.09 (2.2)	1.55 (39.3)	1.84 (46.8)
XBQT25TG	0.24 (6.2)	3.25 (82.5)	0.09 (2.2)	1.69 (42.8)	1.98 (50.3)

## Notes

① For ordering information, see [Page V7-T42-105](#).

② For information on Printed Marking Tag Options, see [Page V7-T42-98](#).

For additional accessories, see [Page V7-T42-90](#).

## Hybrid Terminal Blocks

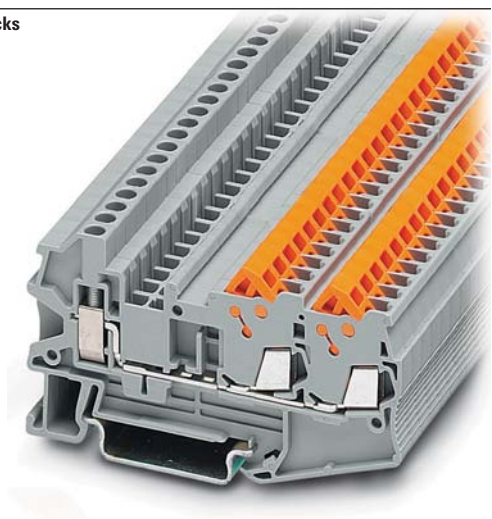

## Contents

<i>Description</i>	<i>Page</i>
Single Level . . . . .	V7-T42-68
Multi-Conductor . . . . .	V7-T42-70
Double Level . . . . .	V7-T42-73
Fuse Terminal Blocks . . . . .	V7-T42-75
Disconnect and Component Terminal Blocks . . . . .	V7-T42-77
Hybrid Terminal Blocks	
Accessories . . . . .	V7-T42-80
Technical Data and Specifications . . . . .	V7-T42-81
Dimensions . . . . .	V7-T42-81

## Hybrid Terminal Blocks

## Product Description

The XBQT hybrid terminal blocks offer the best of both worlds. One side offers the time-saving advantage of our insulation displacement

connection technology, while the other side offers a universal screw connection. Use the IDC side on the internal (factory) control

cabinet side and the screw connection on the end customer (field) side. Ground terminal blocks of the same shape are also available

## Product Selection

## XBQU25

## IDC—Hybrid Terminal Blocks, Single Level



Terminal Width	Maximum Wire Size	IEC Screw Connection in V/A/AWG	IEC IDC Connection in V/A/AWG	UL-cUL Screw Connection in V/A/AWG	UL-cUL IDC Connection in V/A/AWG	Color	Standard Pack	Catalog Number
5.2 mm	12 AWG/2.5 mm <sup>2</sup>	800/17.5/26–12	800/17.5/24–16	600/10/26–12	600/10/24–16	Gray	50	XBQU15
6.2 mm	10 AWG/4 mm <sup>2</sup>	800/24/26–10	800/24/20–14	600/15/26–10	600/15/20–14	Gray	50	XBQU25

## XBQU15D12

## IDC—Hybrid Terminal Blocks, Three-Wire



Terminal Width	Maximum Wire Size	IEC Screw Connection in V/A/AWG	IEC IDC Connection in V/A/AWG	UL-cUL Screw Connection in V/A/AWG	UL-cUL IDC Connection in V/A/AWG	Color	Standard Pack	Catalog Number
5.2 mm	12 AWG/2.5 mm <sup>2</sup>	800/17.5/26–12	800/17.5/24–16	800/10/26–12	800/10/24–16	Gray	50	XBQU15D12
6.2 mm	10 AWG/4 mm <sup>2</sup>	800/24/26–10	800/24/20–14	600/15/26–10	600/15/20–14	Gray	50	XBQU25D12

## XBQU25PE

## IDC—Hybrid Terminal/Ground Blocks

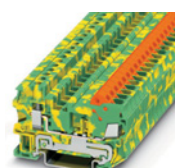

Terminal Width	Maximum Wire Size	IEC Screw Connection in V/A/AWG	IEC IDC Connection in V/A/AWG	UL-cUL Screw Connection in V/A/AWG	UL-cUL IDC Connection in V/A/AWG	Color	Standard Pack	Catalog Number
5.2 mm	12 AWG/2.5 mm <sup>2</sup>	—/—/26–12	—/—/24–16	—/—/26–12	—/—/24–16	Gray	50	XBQU15PE
6.2 mm	10 AWG/4 mm <sup>2</sup>	—/—/26–10	—/—/20–14	—/—/26–10	—/—/20–14	Gray	50	XBQU25PE



## Accessories

## IDC—Hybrid Terminal Blocks

Description	Color	Number of Positions	Standard Pack	XBQU15 Catalog Number	XBQU25 Catalog Number	XBQU15D12 Catalog Number	XBQU25D12 Catalog Number
End cover	Gray	—	10	XBACQU15	XBACQU25	XBACQU15D12	XBACQU25D12
End segment	Gray	—	10	—	—	XBASQT15	XBASQT25
Partition plate	—	—	10	XBATQT25	XBATQT25	XBATQTD12	XBATQTD12
Plug-in bridge—for cross connections in the bridge shaft	Red	2	10	XBAFBS25	XBAFBS26	XBAFBS25	XBAFBS26
		3	10	XBAFBS35	XBAFBS36	XBAFBS35	XBAFBS36
		5	10	XBAFBS55	XBAFBS56	XBAFBS55	XBAFBS56
		10	10	XBAFBS105	XBAFBS106	XBAFBS105	XBAFBS106
		50	10	XBAFBS505	XBAFBS506	XBAFBS505	XBAFBS506
Test adapter	—	—	10	XBATSPA14	XBATSPA14	XBATSPA14	XBATSPA14
2.3 mm diameter test plug	—	—	—	XBATSMPS- <sup>①</sup>	XBATSMPS- <sup>①</sup>	XBATSMPS- <sup>①</sup>	XBATSMPS- <sup>①</sup>
Modular test plug	—	—	10	XBATSPS5	XBATSPS6	XBATSPS5	XBATSPS6
Blank marker strip center and external marking	White	—	10	XBMZBF5 <sup>②</sup>	XBMZBF6 <sup>②</sup>	XBMZBF5 <sup>②</sup>	XBMZBF6 <sup>②</sup>
Blank marker strip center labeling (strip of 10)	—	—	—	XBMZB5 <sup>②</sup>	XBMZB6 <sup>②</sup>	XBMZB5 <sup>②</sup>	XBMZB6 <sup>②</sup>

## IDC—Hybrid Terminal/Ground Blocks

Description	Color	Number of Positions	Standard Pack	XBQU15PE Catalog Number	XBQU25PE Catalog Number
End cover	Gray	—	10	XBACQU15	XBACQU25
Partition plate	—	—	10	XBATQT25	XBATQT25
Plug-in bridge—for cross connections in the bridge shaft	Red	2	10	XBAFBS25	XBAFBS26
		3	10	XBAFBS35	XBAFBS36
		5	10	XBAFBS55	XBAFBS56
		10	10	XBAFBS105	XBAFBS106
		50	10	XBAFBS505	XBAFBS506
Test adapter	—	—	10	XBATSPA14	XBATSPA14
2.3 mm diameter test plug	—	—	—	XBATSMPS- <sup>①</sup>	XBATSMPS- <sup>①</sup>
Modular test plug	—	—	10	XBATSPS5	XBATSPS6
Blank marker strip center and external marking	White	—	10	XBMZBF5 <sup>②</sup>	XBMZBF6 <sup>②</sup>
Blank marker strip center labeling (strip of 10)	—	—	—	XBMZB5 <sup>②</sup>	XBMZB6 <sup>②</sup>

## Notes

① For ordering information, see [Page V7-T42-105](#).

② For information on Printed Marking Tag Options, see [Page V7-T42-98](#).

For additional accessories, see [Page V7-T42-90](#).



## Technical Data and Specifications

### Screw Connection Single Level—Through-Feed

Description	XBQU15	XBQU25	XBQU15PE	XBQU25PE	XBQU15D12	XBQU25D12
<b>Technical Data in Accordance with IEC</b>						
Maximum load current in A/cross-section in mm <sup>2</sup>	17.5/1.5	24/2.5	—	—	17.5/1.5	24/2.5
Rated surge voltage in kV/contamination class	8/3	8/3	8/3	8/3	8/3	8/3
Surge voltage category/insulating material group	III/I	III/I	III/I	III/I	III/I	III/I
<b>Connection Cross-Section</b>						
Core insulation	PVC/PE	PVC/PE	PVC/PE	PVC/PE	PVC/PE	PVC/PE
Single/multiple/fine strand in mm <sup>2</sup>	1.5	2.5	1.5	2.5	1.5	2.5
Halogen-free in mm <sup>2</sup>	1.5	2.5	1.5	2.5	1.5	2.5
Fine strand/superfine strand in AWG (mm <sup>2</sup> )	24–16 (0.25–0.34)	20–14 (—)	24–16 (0.25–0.34)	20–14 (—)	24–16 (0.25–0.34)	20–14 (—)
Repeated connections minimum 100 x in mm <sup>2</sup>	0.25–1.5	0.5–2.5	0.25–1.5	0.5–2.5	0.25–1.5	0.5–2.5
<b>Connection Capacity—Screw Connection</b>						
Stranded with ferrule/with ferrule and plastic sleeve in mm <sup>2</sup>	0.25–2.5/0.25–2.5	0.25–4/0.25–4	0.25–2.5/0.25–2.5	0.25–4/0.25–4	0.25–2.5/0.25–2.5	0.25–4/0.25–4
<b>Multi-Conductor Connection</b> (same cross-section)						
Solid/stranded in mm <sup>2</sup>	0.14–1.5/0.14–1.5	0.14–1.5/0.14–1.5	0.14–1.5/0.14–1.5	0.14–1.5/0.14–1.5	0.14–1.5/0.14–1.5	0.14–1.5/0.14–1.5
Stranded with ferrules without plastic sleeve in mm <sup>2</sup>	0.25–1.5	0.25–1.5	0.25–1.5	0.25–1.5	0.25–1.5	0.25–1.5
Stranded with twin ferrule with plastic sleeve in mm <sup>2</sup>	0.5–1.5	0.5–2.5	0.5–1.5	0.5–2.5	0.5–1.5	0.5–2.5
Stripping length in inches (mm)	0.35 (9)	0.35 (9)	0.35 (9)	0.35 (9)	0.35 (9)	0.35 (9)
Thread	M3	M3	M3	M3	M3	M3
Torque in in-lb (Nm)	5.3–7.1 (0.6–0.8)	5.3–7.1 (0.6–0.8)	5.3–7.1 (0.6–0.8)	5.3–7.1 (0.6–0.8)	5.3–7.1 (0.6–0.8)	5.3–7.1 (0.6–0.8)

## Dimensions

Approximate Dimensions in Inches (mm)

### Screw Connection Single Level—Through-Feed

Catalog Number	Width	Length	Cover Width	Height for—	
				35 x 7.5 in	35 x 15 in
XBQU15	0.20 (5.2)	2.31 (58.8)	0.09 (2.2)	1.69 (42.8)	1.98 (50.3)
XBQU25	0.24 (6.2)	2.46 (62.6)	0.09 (2.2)	1.69 (42.8)	1.98 (50.3)
XBQU15PE	0.20 (5.2)	2.31 (58.8)	0.09 (2.2)	1.69 (42.8)	1.98 (50.3)
XBQU25PE	0.24 (6.2)	2.46 (62.6)	0.09 (2.2)	1.69 (42.8)	1.98 (50.3)
XBQU15D12	0.20 (5.2)	3.01 (76.4)	0.09 (2.2)	1.69 (42.8)	1.98 (50.3)
XBQU25D12	0.24 (6.2)	3.25 (82.5)	0.09 (2.2)	1.69 (42.8)	1.98 (50.3)

#### Miniature Circuit Breakers



42

#### Contents

##### Description

##### Page

Miniature Circuit Breakers	
Circuit Breakers. . . . .	<b>V7-T42-83</b>
Flat-Type Fuse Terminal Blocks. . . . .	<b>V7-T42-86</b>
Spring Cage Fuse Terminal Blocks . . . . .	<b>V7-T42-88</b>

### Miniature Circuit Breakers Overview

#### Product Description

The new **XB** Series thermal miniature circuit breaker offers convenient overload protection. This space-saving single-pole circuit breaker, available up to 10 amps, can be inserted into a screw connection fuse terminal block, XBUK6FSI, or a spring cage fuse terminal block, XBPT4FSI, which is available with or without light indication. The XBATCP combines the

reclosing capability of a circuit breaker with the overload protection of a fuse. The integrated switching function makes it possible to switch the circuit breaker back on immediately, guaranteeing system availability. The device can also be used for switching purposes, as an ON/OFF switch. The Plug-in design allows for quick and efficient replacement.

#### Standards and Certifications

- UL and cUL recognized
- UL 1077—File No. E301915
- CE approved



Circuit Breakers



Contents

<b>Description</b>	<b>Page</b>
Circuit Breakers	
Accessories	V7-T42-84
Technical Data and Specifications	V7-T42-84
Time/Current Curve	V7-T42-85
Dimensions	V7-T42-85
Flat-Type Fuse Terminal Blocks	V7-T42-86
Spring Cage Fuse Terminal Blocks	V7-T42-88

Circuit Breakers

Product Description

The thermal miniature circuit breaker can be switched back on again, has a compact design, and is available

in 10 finely graded steps for nominal currents from 0.1 to 10A.

Product Selection

XBAT

Thermal Miniature Circuit Breaker



Connection Data in Vac/Vdc	Nominal Current	Color	Standard Pack	Catalog Number
250/65	0.1A	Black	20	<b>XBATCPT</b>
	0.25A	Black	20	<b>XBATCPQ</b>
	0.5A	Black	20	<b>XBATCPH</b>
	1.0A	Black	20	<b>XBATCP1</b>
	2.0A	Black	20	<b>XBATCP2</b>
	3.0A	Black	20	<b>XBATCP3</b>
	4.0A	Black	20	<b>XBATCP4</b>
	6.0A	Black	20	<b>XBATCP6</b>
	8.0A	Black	20	<b>XBATCP8</b>
	10.0A	Black	20	<b>XBATCP10</b>

## Accessories

## Thermal Miniature Circuit Breaker

Description	Color	Number of Positions	Standard Pack	XBAT Catalog Number
Blank marker strip	White	—	10	<b>XBZBF5</b> ①
Flat type terminal blocks	—	—	—	<b>XBK6FSI</b> <b>XBK6FSIL12</b> <b>XBK6FSIL24</b> <b>XBPT4FSI</b> <b>XBPT4FSIL12</b> <b>XBPT4FSIL24</b>

## Technical Data and Specifications

## Thermal Miniature Circuit Breaker

Description	XBAT
<b>Technical Data in Accordance with IEC</b>	
Nominal voltage in Vac/Vdc	250/65
Nominal current in A	0.25–10
Ambient temperature	–4 to 140°F (–20 to 60°C)
<b>Maximum Power Dissipation</b>	
Rated surge voltage in kV/contamination class	2.5/2
Surge voltage category/insulating material group	III/I
<b>Switching Capacity</b>	
Cycles with 1 x I <sub>N</sub> (low-induction)	6000
Cycles with 1 x I <sub>N</sub> (induction)	3000
Cycles with 2 x I <sub>N</sub> (induction)	500
<b>Switching Capacity I CN</b>	
For nominal currents of 0.25–4A/6–10A	6 x I <sub>N</sub> /8 x I <sub>N</sub>
Switching capacity (UL 1077) 250 Vac/65 Vdc	2000/200

## Nominal Currents and Internal Resistances

Nominal Current (A)	Internal Resistance (3/4)
0.25	14
0.5	3.4
1.0	0.9
2.0	0.25
3.0	0.11
4.0	0.07
6.0	≤ 0.05
8.0	≤ 0.05
10.0	≤ 0.05

**Note**

① For information on Printed Marking Tag Options, see **Page V7-T42-98**.

## Time/Current Curve

### Total Switch-Off Period for Nominal Current, 73.4°F (23°C)

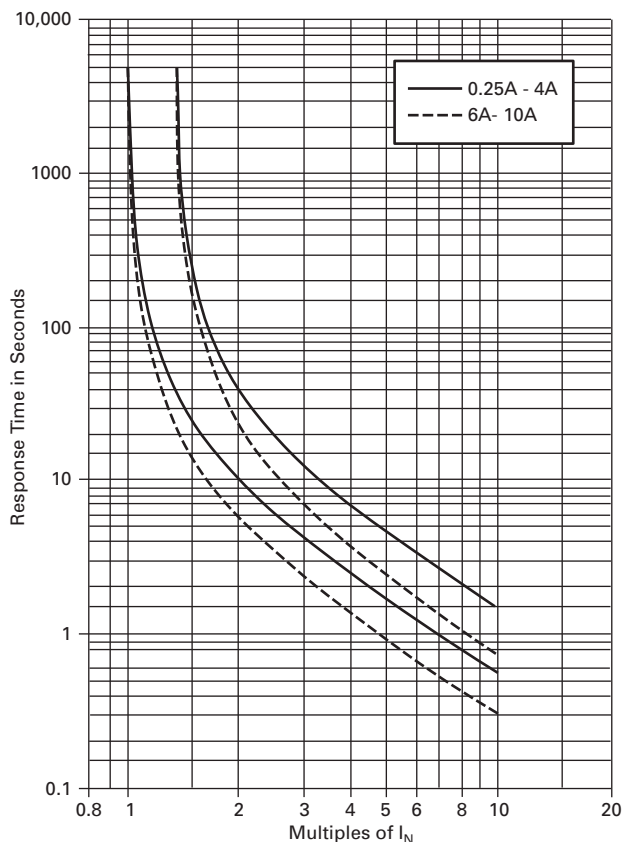

**Note:** When mounted in rows, the nominal current of the devices can only be transmitted at 80% or must be correspondingly over-dimensioned.

## Temperature Factor

Ambient Temperature	Temperature Factor
-4°F (-20°C)	0.76
14°F (-10°C)	0.84
32°F (0°C)	0.91
73.4°F (23°C)	1.00
104°F (40°C)	1.08
122°F (50°C)	1.16
140°F (60°C)	1.24

## Dimensions

Approximate Dimensions in Inches (mm)

### XBUK6FSI with XBAT

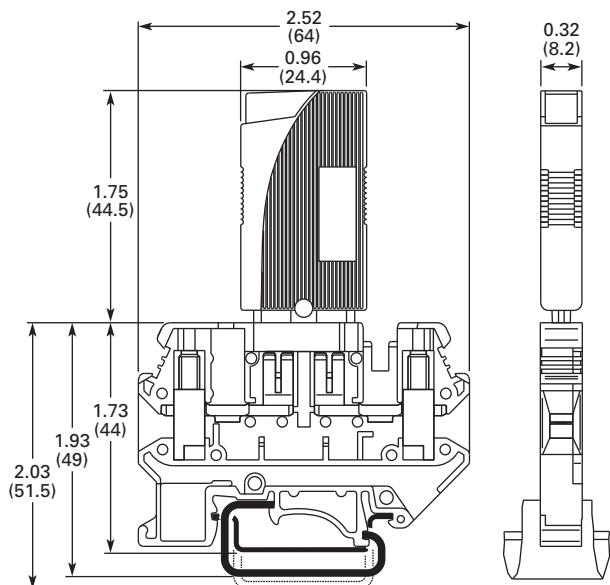

### XBPT4FSI with XBAT

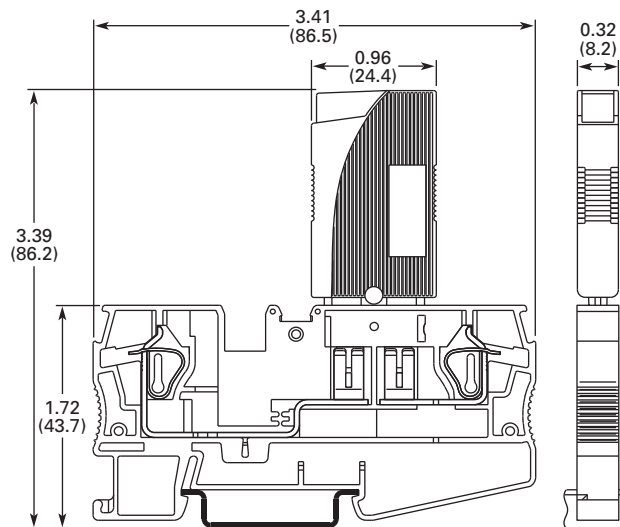

Flat-Type Fuse Terminal Blocks

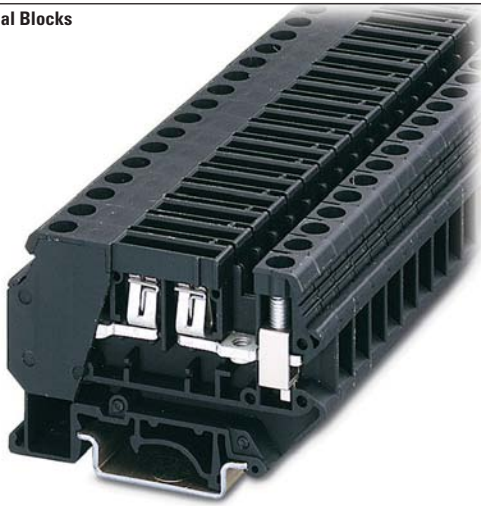

### Contents

<i>Description</i>	<i>Page</i>
Circuit Breakers .....	<b>V7-T42-83</b>
Flat-Type Fuse Terminal Blocks	
Accessories .....	<b>V7-T42-86</b>
Technical Data and Specifications .....	<b>V7-T42-87</b>
Dimensions .....	<b>V7-T42-87</b>
Spring Cage Fuse Terminal Blocks .....	<b>V7-T42-88</b>

### Flat-Type Fuse Terminal Blocks

#### Product Description

The fuse terminal blocks can be used as a basic terminal blocks for the XBAT overload miniature circuit breaker, see **Page V7-T42-83**.

#### Product Selection

**XBUK6FSI**

#### Screw Connection Flat-Type Fuse Terminal Blocks



Terminal Width	Maximum Wire Size	Connection Data in V/A/AWG	UL-cUL Ratings in V/A/AWG	Color	Standard Pack	Catalog Number
<b>Flat-Type Fuse Terminal Block</b>						
8.2 mm	8 AWG/6 mm <sup>2</sup>	250/—/24–8	300/30/26–8	Black	50	<b>XBUK6FSI</b>
<b>Flat-Type Fuse Terminal Block with LED, Red 12 Vdc, 2.0 mA</b>						
8.2 mm	8 AWG/6 mm <sup>2</sup>	250/—/24–8	300/30/26–8	Black	50	<b>XBUK6FSIL12</b>
<b>Flat-Type Fuse Terminal Block with LED, Red 24 Vdc, 2.0 mA</b>						
8.2 mm	8 AWG/6 mm <sup>2</sup>	250/—/24–8	300/30/26–8	Black	50	<b>XBUK6FSIL24</b>

#### Accessories

##### Flat-Type Fuse Terminal Blocks

Description	Color	Number of Positions	Standard Pack	XBUK6FSI Catalog Number	XBUK6FSIL_ Catalog Number
Blank marker strip	White	—	10	<b>XBMZB8</b> ①	<b>XBMZB8</b> ①

**Note**

① For information on Printed Marking Tag Options, see **Page V7-T42-98**.

## Technical Data and Specifications

### Flat-Type Fuse Terminal Blocks

Description	XBUK6FSI	XBUK6FSIL <sub>2</sub>
<b>Technical Data in Accordance with IEC</b>		
Fuse type ISO	C	C
Maximum current with single arrangement in A	30	30
<b>Maximum Power Dissipation</b>		
Rated surge voltage in kV/contamination class	4/3	4/3
Surge voltage category/insulating material group	III/I	III/I
<b>Connection Capacity</b>		
Stranded with ferrule with plastic sleeve in mm <sup>2</sup>	0.25–4	0.25–4
Stranded with ferrule without plastic sleeve in mm <sup>2</sup>	0.25–6	0.25–6
Stranded with twin ferrule with plastic sleeve in mm <sup>2</sup>	—	—
<b>Multi-Conductor Connection</b> (same cross-section)		
Solid/stranded in mm <sup>2</sup>	0.2–2.5/0.2–2.5	0.2–2.5/0.2–2.5
Stranded with ferrules without plastic sleeve in mm <sup>2</sup>	0.25–2.5	0.25–2.5
Stranded with twin ferrule with plastic sleeve in mm <sup>2</sup>	0.5–4.0	0.5–4.0
Stripping length in inches (mm)	0.39 (10)	0.39 (10)
Thread	M4	M4
Torque in in-lb (Nm)	13.3–14.2 (1.5–1.6)	13.3–14.2 (1.5–1.6)

## Dimensions

Approximate Dimensions in Inches (mm)

### Flat-Type Fuse Terminal Blocks

Catalog Number	Width	Length	Height for—		
			32 in	35 x 7.5 in	35 x 15 in
XBUK6FSI	0.32 (8.2)	2.91 (74.0)	2.24 (57.0)	2.05 (52.0)	2.34 (59.5)
XBUK6FSIL <sub>12</sub>	0.32 (8.2)	2.91 (74.0)	2.24 (57.0)	2.05 (52.0)	2.34 (59.5)
XBUK6FSIL <sub>24</sub>	0.32 (8.2)	2.91 (74.0)	2.24 (57.0)	2.05 (52.0)	2.34 (59.5)

#### Spring Cage Fuse Terminal Blocks



### Contents

<i>Description</i>	<i>Page</i>
Circuit Breakers . . . . .	<b>V7-T42-83</b>
Flat-Type Fuse Terminal Blocks . . . . .	<b>V7-T42-86</b>
Spring Cage Fuse Terminal Blocks	
Accessories . . . . .	<b>V7-T42-88</b>
Technical Data and Specifications . . . . .	<b>V7-T42-89</b>
Dimensions . . . . .	<b>V7-T42-89</b>

### Spring Cage Fuse Terminal Blocks

#### Product Description

Flat-type fuses or the XBAT miniature circuit breaker (see **Page V7-T42-83**) can be used as the fuse element in these XBPT

Spring Cage Fuse Terminal Blocks. Terminal blocks with a light indicator are available for quick error diagnosis.

#### Product Selection

##### XBPT4FSI

#### Spring Cage Fuse Terminal Blocks



Terminal Width	Maximum Wire Size	Connection Data in V/A/AWG	UL-cUL Ratings in V/A/AWG	Color	Standard Pack	Catalog Number
<b>Spring Cage Fuse Terminal Block</b>						
8.2 mm	10 AWG/4 mm <sup>2</sup>	400/30/28–10	300/30/24–10	Black	50	<b>XBPT4FSI</b>
<b>Spring Cage Fuse Terminal Block with LED, Red 12 Vdc, 2.0 mA</b>						
8.2 mm	10 AWG/4 mm <sup>2</sup>	400/30/28–10	300/30/24–10	Black	50	<b>XBPT4FSIL12</b>
<b>Spring Cage Fuse Terminal Block with LED, Red 24 Vdc, 2.0 mA</b>						
8.2 mm	10 AWG/4 mm <sup>2</sup>	400/30/28–10	300/30/24–10	Black	50	<b>XBPT4FSIL24</b>

### Accessories

#### Flat-Type Fuse Terminal Blocks

Description	Color	Number of Positions	Standard Pack	XBPT4FSI Catalog Number	XBPT4FSIL_ Catalog Number
Test adapter	—	—	10	<b>XBATSPA14</b>	<b>XBATSPA14</b>
2.3 mm diameter test plug	—	—	—	<b>XBATSMPS-<sup>①</sup></b>	<b>XBATSMPS-<sup>①</sup></b>
Modular test plug	—	—	10	<b>XBATSPS8</b>	<b>XBATSPS8</b>
Blank marker strip center and external marking	White	—	10	<b>XBZBF8<sup>②</sup></b>	<b>XBZBF8<sup>②</sup></b>
Blank marker strip center labeling (strip of 10)	White	—	10	<b>XBZB8<sup>②</sup></b>	<b>XBZB8<sup>②</sup></b>

#### Notes

- ① For ordering information, see **Page V7-T42-105**.
- ② For information on Printed Marking Tag Options, see **Page V7-T42-98**.



## Technical Data and Specifications

### Flat-Type Fuse Terminal Blocks

Description	XBPT4FSI	XBPT4FSIL_
<b>Technical Data in Accordance with IEC</b>		
Fuse type ISO	C	C
Maximum current with single arrangement in A	30	30
<b>Maximum Power Dissipation</b>		
Rated surge voltage in kV/contamination class	6/3	6/3
Surge voltage category/insulating material group	III/I	III/I
<b>Connection Capacity</b>		
Stranded with ferrule with plastic sleeve in mm <sup>2</sup>	0.25–4	0.25–4
Stranded with ferrule without plastic sleeve in mm <sup>2</sup>	0.25–4	0.25–4
Stranded with twin ferrule with plastic sleeve in mm <sup>2</sup>	0.5	0.5
Stripping length in inches (mm)	0.39 (10)	0.39 (10)

### Dimensions

Approximate Dimensions in Inches (mm)

### Flat-Type Fuse Terminal Blocks

Catalog Number	Width	Length	Height for—	
			35 x 7.5 in	35 x 15 in
XBPT4FSI	0.32 (8.2)	3.41 (86.5)	1.71 (43.5)	2.01 (51.0)
XBPT4FSIL12	0.32 (8.2)	3.41 (86.5)	1.71 (43.5)	2.01 (51.0)
XBPT4FSIL24	0.32 (8.2)	3.41 (86.5)	1.71 (43.5)	2.01 (51.0)

## XB Series Accessories

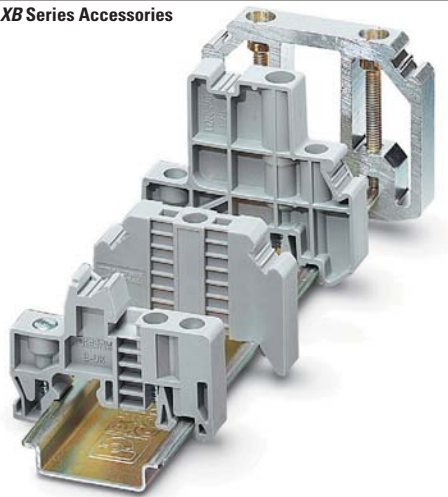

## XB Series Accessories Overview

**End Stops**

The end stop provides an anchor point at each end of the rail assembly by attaching directly to the DIN rail. A wide range of end stop options are available, including those that mount with one or multiple screws and those that do not require screws for mounting. End stops also have a location for marking material to be placed.

**DIN Rail**

Eaton offers ways for time-saving and secure mounting of components needed for electrical connections. DIN rail provides the basis for the inner design of the control cabinet and ensures a firm hold of the rail-mountable components. Eaton offers a wide range of standard DIN rails sizes and materials, solid or slotted. Or, contact us about custom lengths of pre-cut rail or ordering pre-drilled rail. The DIN rails are designed in accordance with the European standard EN 60715.

**Angled Mounting Brackets**

Angled mounting brackets are used to mount DIN rail at a more accessible angle for wiring and troubleshooting.

**Ferrules**

Ferrules are available with or without an insulating sleeve. The plastic insulating sleeve simplifies the fitting of the conductor and the color indicates the size of the cross-section. The closer the connections are, the more reliable the insulation is and the less likely the wires are to splice. Twin ferrules are also available allowing two wires to be easily compressed in one ferrule. Chain bridging, frequently used in industry, becomes easier with twin ferrules.

**Contents****Description****Page**

XB Series Accessories	
End Stops	V7-T42-91
DIN Rails	V7-T42-92
Angled Mounting Brackets	V7-T42-93
Ferrules	V7-T42-94
Hand Tools	V7-T42-97
Marking Accessories	V7-T42-98
Testing Accessories	V7-T42-105
Separating Plates, Covers and Bridges	V7-T42-105

**Hand Tools**

Eaton offers an array of hand tools to make it easier to work with our terminal blocks. The XBTCUTSTP tool is recommended for cutting and stripping PVC insulated wires. The ergonomically shaped crimping pliers, XBTCRMP66, result in fatigue-free work by spreading the manual force equally between the six jaws. The XBTDVR screwdrivers have a rotating cap that prevents user discomfort even at high torques and allows rapid rotation. The ergonomically shaped handle further aids the user's comfort. The blade is made from CVM steel, hardened and chrome-plated.

**Marking Accessories**

The marking system provides logical and clear identification of the modular terminal blocks and interface modules. The blank marker strip is designed for marking terminal blocks, equipment and smaller modules with marker grooves. The marker strip is available in all common pitches in printed and unprinted versions.

**Testing Accessories**

The range of test accessories available includes different test plugs, so that an optimum solution can be realized for every application. In addition to pre-assembled test plugs, plugs are also available that can be configured individually to form test adapters.

## End Stops

### Product Selection

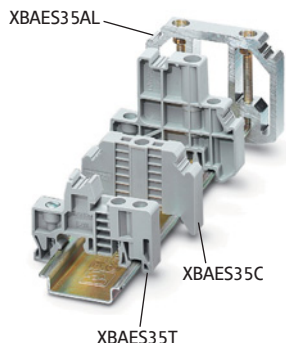

### Snap-On End Stop (15 mm)

Standard Pack	Catalog Number
50	XBAES15N

### Snap-On End Stop (35 mm)

Standard Pack	Catalog Number
50	XBAES35N

Snap-on end stops for 35 mm and 15 mm DIN rails can be fitted with blank marker strips and adjustable terminal strip markers, parking facility for bridges and testing accessories.

### Universal End Stop (15 mm)

Standard Pack	Catalog Number
50	XBAES15C

### Universal End Stop (35 mm)

Standard Pack	Catalog Number
50	XBAES35T
50	XBAES35C

Screwed on, labeling with blank marker strips and terminal strip markers.

### Aluminum End

Standard Pack	Catalog Number
10	XBAES35AL

Snaps on, for end support of 50–240 mm terminal blocks, labeling with XBMZB10.

### Cross-Reference of Terminal Blocks Marking, End Stops

Catalog Number	XBMKLM2	XBMGLMA	XBMUBE
XBAES35N	X	—	—
XBAES35T	—	X	X

### Dimensions

Approximate Dimensions in Inches (mm)

#### Snap-On End Stop

##### XBAES35N

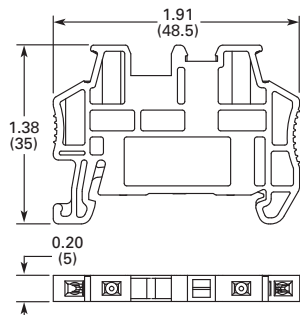

##### XBAES15N

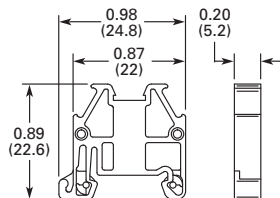

#### Aluminum End Stop

##### XBAES35AL

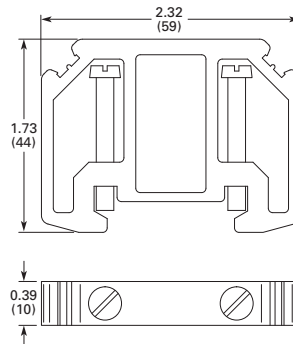

#### Universal End Stop

##### XBAES35T

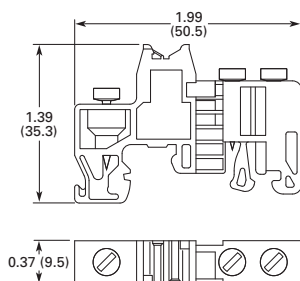

##### XBAES35C

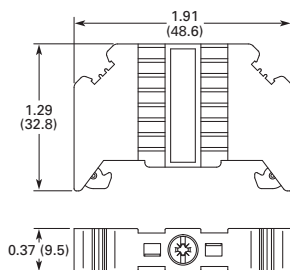

##### XBAES15C

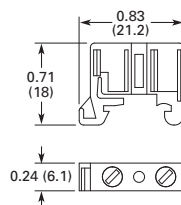

# 42.1

## Terminal Blocks, Fuse Blocks and Fuse Holders

IEC—XB Series

### DIN Rails

#### Product Selection

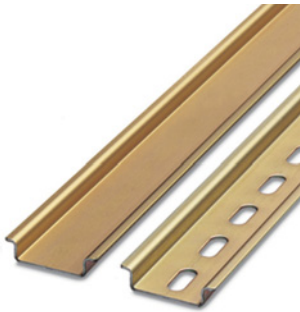

Perforated and unperforated DIN rails in accordance with E 60715.

#### Features

- High dimensional accuracy
- Restricted tolerances
- Double surface tempering, galvanized and chromated
- All 2m in length
- Customization available

#### 35 x 7.5 mm x 2m

Standard Pack	Catalog Number
<b>Slotted</b>	
25	<b>XBANS3575P</b>
<b>Solid</b>	
25	<b>XBANS3575U</b>

#### 35 x 15 mm x 2m

Standard Pack	Catalog Number
<b>Slotted</b>	
25	<b>XBANS3515P</b>
<b>Solid</b>	
25	<b>XBANS3515U</b>

#### 15 x 5.5 mm x 2m

Standard Pack	Catalog Number
25	<b>XBANS15P</b>

#### Aluminum DIN Rails (Perforated)

Standard Pack	Catalog Number
<b>35/7.5/2m</b>	
25	<b>XBANS3575PL</b>
<b>35/58/2m</b>	
6	<b>XBANS35PL</b>

42

### Dimensions

Approximate Dimensions in Inches (mm)

#### 35 x 7.5 mm DIN Rail

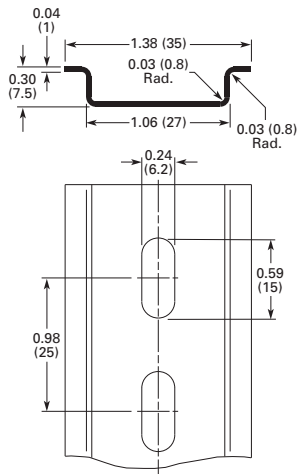

#### 35 x 15 mm DIN Rail

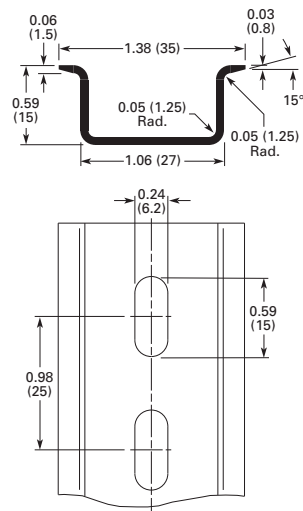

#### 15 x 5.5 mm x 2m DIN Rail

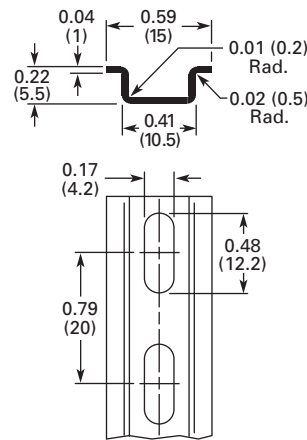

#### XBANS35PL Raised Rail

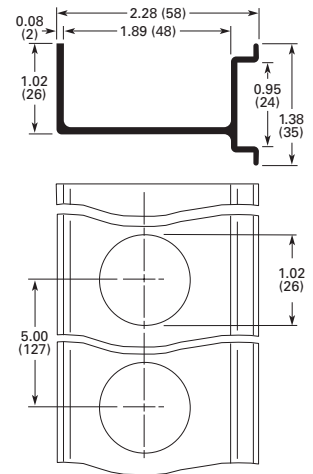

## Angled Mounting Brackets

### Product Selection



The angled brackets enable the DIN rail to be mounted with a spacing or at an angle of 30°.

### Features

- For mounting DIN rail at 30° angle
- For use with M6 screw
- Chromated steel
- Provides better visibility

### Angled Mounting Bracket

Standard Pack	Catalog Number
<b>Height Inches (mm)</b> <b>1.39 (35.4)</b>	
10	<b>XBANBGS</b>
<b>Height Inches (mm)</b> <b>1.81 (46)</b>	
10	<b>XBANBGSH</b>

### Dimensions

Approximate Dimensions in Inches (mm)

#### XBANBGS

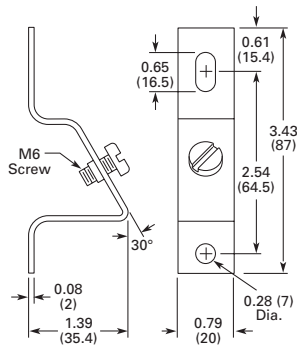

#### XBANBGSH

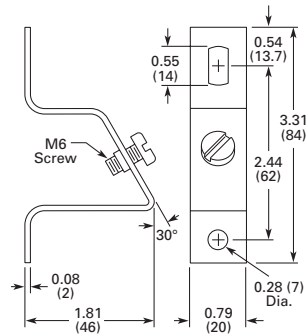

# 42.1

## Terminal Blocks, Fuse Blocks and Fuse Holders

IEC—XB Series

### Ferrules

#### Product Selection

Ferrules are offered in two basic designs—an insulated style available in models for wire sizes 20 through 4 AWG and a non-insulated type available in models for wire sizes 22 through 2 AWG.

**Note:** UL Ratings do not typically pertain to the use of Ferrules—Ferrules are covered under DIN VDE 0611.

42

#### Insulated

- Tube: soft electrolytic copper (E-CU), tin plated
- Plastic sleeve: polypropylene
  - Long-term temperature 105°C
  - Short-term temperature 120°C

XBAF1



#### Insulated Ferrules

Wire Size AWG (mm <sup>2</sup> )	Color <sup>①</sup>	Standard Pack <sup>②</sup>	Catalog Number
20 (0.5)	White	100	XBAF1
18 (0.75)	Gray	100	XBAF3
18 (1)	Red	100	XBAF4
16 (1.5)	Black	100	XBAF6
14 (2.5)	Blue	100	XBAF9
14 (2.5)	Blue	100	XBAF10
12 (4)	Gray	100	XBAF11
12 (4)	Gray	100	XBAF12
10 (6)	Yellow	100	XBAF13
10 (6)	Yellow	100	XBAF14
8 (10)	Red	100	XBAF15
8 (10)	Red	100	XBAF16
6 (16)	Blue	100	XBAF17
6 (16)	Blue	100	XBAF18
4 (25)	Yellow	50	XBAF19

#### Non-Insulated

- Tube: soft electrolytic copper (E-CU), tin plated

XBAF20

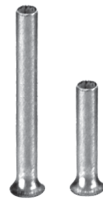

#### Non-Insulated Ferrules

Wire Size AWG (mm <sup>2</sup> )	Standard Pack <sup>②</sup>	Catalog Number
20 (0.5)	100	XBAF20
18 (0.75)	100	XBAF21
18 (1)	100	XBAF23
16 (1.5)	100	XBAF24
14 (2.5)	100	XBAF25
12 (4)	100	XBAF26
10 (6)	100	XBAF27
8 (10)	100	XBAF28
6 (16)	100	XBAF29

#### Special Applications

The twin ferrules allow two conductors to be compressed practically in one ferrule.

The colored coding of the various cross sections corresponds to DIN 46 228-4.

XBAFT1



#### Non-Insulated Twin Ferrules

Wire Size AWG (mm <sup>2</sup> )	Color <sup>①</sup>	Standard Pack <sup>②</sup>	Catalog Number
20 (0.5)	White	100	XBAFT1
18 (0.75)	Gray	100	XBAFT3
18 (1)	Red	100	XBAFT4
16 (1.5)	Black	100	XBAFT6
14 (2.5)	Blue	100	XBAFT9
12 (4)	Gray	100	XBAFT11
10 (6)	Yellow	100	XBAFT13
8 (10)	Red	100	XBAFT15
6 (16)	Blue	50	XBAFT18

#### Notes

- ① The colored coding of the various cross-sections corresponds to DIN 46 228-4.
- ② Standard pack is the number of ferrules that come in each bag. Must order in multiples of standard pack.  
*Example: XBAF1*—an order for 200 pieces will receive 2 bags of ferrules, each with 100 pieces.

**Dimensions**

Approximate Dimensions in Inches (mm)

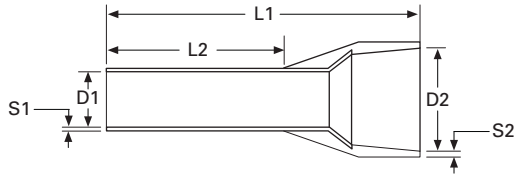
**Ferrules with Insulating Collar**

Catalog Number	Approximate Dimensions					
	D1	D2	L1	L2	S1	S2
XBAF1	0.04 (1.1)	0.10 (2.5)	0.55 (14.0)	0.31 (8.0)	0.006 (0.15)	0.010 (0.25)
XBAF3	0.05 (1.3)	0.11 (2.8)	0.55 (14.0)	0.31 (8.0)	0.006 (0.15)	0.010 (0.25)
XBAF4	0.06 (1.5)	0.12 (3.0)	0.55 (14.0)	0.31 (8.0)	0.006 (0.15)	0.012 (0.30)
XBAF6	0.07 (1.8)	0.13 (3.4)	0.55 (14.0)	0.31 (8.0)	0.006 (0.15)	0.012 (0.30)
XBAF9	0.09 (2.3)	0.17 (4.2)	0.55 (14.0)	0.31 (8.0)	0.006 (0.15)	0.012 (0.30)
XBAF10	0.09 (2.3)	0.17 (4.2)	0.94 (24.0)	0.71 (18.0)	0.006 (0.15)	0.012 (0.30)
XBAF11	0.11 (2.8)	0.19 (4.8)	0.67 (17.0)	0.39 (10.0)	0.008 (0.20)	0.012 (0.30)
XBAF12	0.11 (2.8)	0.19 (4.8)	1.02 (26.0)	0.71 (18.0)	0.008 (0.20)	0.012 (0.30)
XBAF13	0.14 (3.5)	0.24 (6.2)	0.79 (20.0)	0.47 (12.0)	0.008 (0.20)	0.012 (0.30)
XBAF14	0.14 (3.5)	0.24 (6.2)	1.02 (26.0)	0.71 (18.0)	0.008 (0.20)	0.012 (0.30)
XBAF15	0.18 (4.6)	0.30 (7.5)	0.87 (22.0)	0.47 (12.0)	0.008 (0.20)	0.012 (0.30)
XBAF16	0.18 (4.6)	0.30 (7.5)	1.10 (28.0)	0.71 (18.0)	0.008 (0.20)	0.012 (0.30)
XBAF17	0.23 (5.8)	0.35 (8.8)	0.94 (24.0)	0.47 (12.0)	0.008 (0.20)	0.016 (0.40)
XBAF18	0.23 (5.8)	0.35 (8.8)	1.10 (28.0)	0.71 (18.0)	0.008 (0.20)	0.016 (0.40)
XBAF19	0.29 (7.3)	0.43 (11.0)	1.26 (32.0)	0.71 (18.0)	0.008 (0.20)	0.020 (0.50)

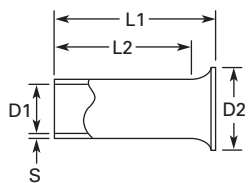
**Ferrules without Insulating Collar**

Catalog Number	Approximate Dimensions				
	D1	D2	L1	L2	S
XBAF20	0.04 (1.0)	0.08 (2.1)	0.24 (6.0)	0.21 (5.3)	0.006 (0.15)
XBAF21	0.05 (1.2)	0.09 (2.3)	0.24 (6.0)	0.21 (5.3)	0.006 (0.15)
XBAF23	0.06 (1.4)	0.10 (2.5)	0.24 (6.0)	0.21 (5.3)	0.006 (0.15)
XBAF24	0.07 (1.7)	0.11 (2.8)	0.28 (7.0)	0.24 (6.0)	0.006 (0.15)
XBAF25	0.09 (2.2)	0.13 (3.4)	0.28 (7.0)	0.24 (6.0)	0.006 (0.15)
XBAF26	0.11 (2.8)	0.16 (4.0)	0.35 (9.0)	0.31 (8.0)	0.008 (0.20)
XBAF27	0.14 (3.5)	0.19 (4.7)	0.47 (12.0)	0.35 (9.0)	0.008 (0.20)
XBAF28	0.18 (4.5)	0.23 (5.8)	0.47 (12.0)	0.43 (10.8)	0.008 (0.20)
XBAF29	0.23 (5.8)	0.30 (7.5)	0.47 (12.0)	0.41 (10.5)	0.008 (0.20)

# 42.1

## Terminal Blocks, Fuse Blocks and Fuse Holders

IEC—XB Series

Approximate Dimensions in Inches (mm)

### Twin Ferrules

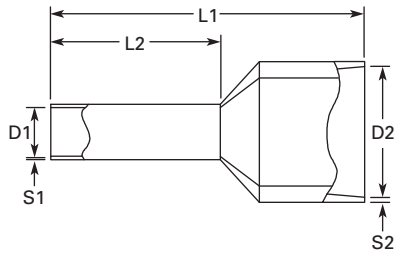

42

Catalog Number	Approximate Dimensions		L1	L2	S1	S2
	D1	D2				
<b>XBAFT1</b>	0.06 (1.5)	0.10 (2.5)	0.59 (15.0)	0.31 (8.0)	0.006 (0.15)	0.010 (0.25)
<b>XBAFT3</b>	0.07 (1.8)	0.11 (2.8)	0.59 (15.0)	0.31 (8.0)	0.006 (0.15)	0.010 (0.25)
<b>XBAFT4</b>	0.08 (2.1)	0.13 (3.4)	0.59 (15.0)	0.31 (8.0)	0.006 (0.15)	0.012 (0.30)
<b>XBAFT6</b>	0.09 (2.3)	0.14 (3.6)	0.63 (16.0)	0.31 (8.0)	0.006 (0.15)	0.012 (0.30)
<b>XBAFT9</b>	0.11 (2.9)	0.17 (4.2)	0.73 (18.5)	0.39 (10.0)	0.008 (0.20)	0.012 (0.30)
<b>XBAFT11</b>	0.15 (3.8)	0.19 (4.9)	0.91 (23.0)	0.47 (12.0)	0.008 (0.20)	0.012 (0.30)
<b>XBAFT13</b>	0.19 (4.9)	0.23 (5.9)	0.98 (25.0)	0.55 (14.0)	0.008 (0.20)	0.016 (0.40)
<b>XBAFT15</b>	0.26 (6.5)	0.28 (7.2)	1.02 (26.0)	0.55 (14.0)	0.008 (0.20)	0.016 (0.40)
<b>XBAFT18</b>	0.33 (8.5)	0.35 (8.8)	1.22 (31.0)	0.63 (16.0)	0.008 (0.20)	0.020 (0.50)



**Hand Tools****Stripping Tools****Product Selection****Stripping Tools**

Standard Pack	Catalog Number
1	XBTCUTSTP

**Technical Data and Specifications****Conductor/Cable Stripping Range**

Description	Specification
Conductor/cable	0.2–6 mm <sup>2</sup> /24–10 AWG
Wire cutter	6 mm <sup>2</sup> /10 AWG

**Crimping Pliers**

The crimping pliers deform the ferrules hexagonally. For 0.25–6 mm<sup>2</sup> ferrules in accordance with DIN 46 228-1: 1992-08 and DIN 46 228-4: 1990-09.

**Product Selection****Crimping Pliers**

Standard Pack	Catalog Number
1	XBTCRMP66

**Technical Data and Specifications****Areas of Application**

Description	Specification
Conductor	0.25–6 mm <sup>2</sup>
Conductor	23–10 AWG

**Slotted Screwdrivers**

The crimping pliers deform the ferrules hexagonally. For 0.25–6 mm<sup>2</sup> ferrules in accordance with DIN 46 228-1: 1992-08 and DIN 46 228-4: 1990-09.

**Product Selection****Slotted Screwdrivers**

Standard Pack	Catalog Number
<b>3.5 mm</b>	
1	XBTDVR35
<b>4.0 mm</b>	
1	XBTDVR40

**Dimensions**

Approximate Dimensions in Inches (mm)

**Stripping Tools**

Length	Stripping Length	Weight In lbs (g)
8.07 (205)	Up to 18 mm	0.44 (200)

**Dimensions**

Approximate Dimensions in Inches (mm)

**Crimping Pliers**

Length	Weight In lbs (g)
6.85 (175)	0.79 (360)

#### Marking Accessories

##### Printed Marking Tag Options

##### Horizontally Printed Marking Tags and Marking Directions

1	2	3	4	5	6	7	8	9	10
---	---	---	---	---	---	---	---	---	----

Marking Direction: Horizontal

1	2	3	4	5	6	7	8	9	10
---	---	---	---	---	---	---	---	---	----

Marking Direction: Vertical

42

##### Marking Tags for 5.2 mm Wide Terminal Blocks

Standard Pack	Number Sequence	Catalog Number
<b>ZB5 Tags Vertically Numbered</b>		
10	1–10 ①	<b>XBMZB5V/1</b>
10	11–20	<b>XBMZB5V/11</b>
10	21–30	<b>XBMZB5V/21</b>
10	31–40	<b>XBMZB5V/31</b>
10	41–50	<b>XBMZB5V/41</b>
10	51–60	<b>XBMZB5V/51</b>
10	61–70	<b>XBMZB5V/61</b>
10	71–80	<b>XBMZB5V/71</b>
10	81–90	<b>XBMZB5V/81</b>
10	91–100	<b>XBMZB5V/91</b>
<b>ZBF5 Tags Vertically Numbered</b>		
10	1–10 ①	<b>XBMZBF5V/1</b>
10	11–20	<b>XBMZBF5V/11</b>
10	21–30	<b>XBMZBF5V/21</b>
10	31–40	<b>XBMZBF5V/31</b>
10	41–50	<b>XBMZBF5V/41</b>
10	51–60	<b>XBMZBF5V/51</b>
10	61–70	<b>XBMZBF5V/61</b>
10	71–80	<b>XBMZBF5V/71</b>
10	81–90	<b>XBMZBF5V/81</b>
10	91–100	<b>XBMZBF5V/91</b>

##### Marking Tags for 6.2 mm Wide Terminal Blocks

Standard Pack	Number Sequence	Catalog Number
<b>ZB6 Tags Vertically Numbered</b>		
10	1–10 ①	<b>XBMZB6V/1</b>
10	11–20	<b>XBMZB6V/11</b>
10	21–30	<b>XBMZB6V/21</b>
10	31–40	<b>XBMZB6V/31</b>
10	41–50	<b>XBMZB6V/41</b>
10	51–60	<b>XBMZB6V/51</b>
10	61–70	<b>XBMZB6V/61</b>
10	71–80	<b>XBMZB6V/71</b>
10	81–90	<b>XBMZB6V/81</b>
10	91–100	<b>XBMZB6V/91</b>
<b>ZBF6 Tags Vertically Numbered</b>		
10	1–10 ①	<b>XBMZBF6V/1</b>
10	11–20	<b>XBMZBF6V/11</b>
10	21–30	<b>XBMZBF6V/21</b>
10	31–40	<b>XBMZBF6V/31</b>
10	41–50	<b>XBMZBF6V/41</b>
10	51–60	<b>XBMZBF6V/51</b>
10	61–70	<b>XBMZBF6V/61</b>
10	71–80	<b>XBMZBF6V/71</b>
10	81–90	<b>XBMZBF6V/81</b>
10	91–100	<b>XBMZBF6V/91</b>

**Note**

① For text printed horizontally, change “V” in catalog number to “H.”

**Marking Tags for 8.2 mm Wide Terminal Blocks**

Standard Pack	Number Sequence	Catalog Number
<b>ZB8 Tags Vertically Numbered</b>		
10	1–10 ①	XBMZB8V/1
10	11–20	XBMZB8V/11
10	21–30	XBMZB8V/21
10	31–40	XBMZB8V/31
10	41–50	XBMZB8V/41
10	51–60	XBMZB6V/51
10	61–70	XBMZB8V/61
10	71–80	XBMZB8V/71
10	81–90	XBMZB8V/81
10	91–100	XBMZB8V/91
<b>ZBF8 Tags Vertically Numbered</b>		
10	1–10 ①	XBMZBF8V/1
10	11–20	XBMZBF8V/11
10	21–30	XBMZBF8V/21
10	31–40	XBMZBF8V/31
10	41–50	XBMZBF8V/41
10	51–60	XBMZBF8V/51
10	61–70	XBMZBF8V/61
10	71–80	XBMZBF8V/71
10	81–90	XBMZBF8V/81
10	91–100	XBMZBF8V/91

**Marking Tags for 10.2 mm Wide Terminal Blocks**

Standard Pack	Number Sequence	Catalog Number
<b>ZB10 Tags Vertically Numbered</b>		
10	1–10 ①	XBMZB10V/1
10	11–20	XBMZB10V/11
10	21–30	XBMZB10V/21
<b>ZBF10 Tags Vertically Numbered</b>		
10	1–10 ①	XBMZBF10V/1
10	11–20	XBMZBF10V/11
10	21–30	XBMZBF10V/21

**Marking Tags for 12 mm Wide Terminal Blocks**

Standard Pack	Number Sequence	Catalog Number
<b>ZB12 Tags Vertically Numbered</b>		
10	1–10 ①	XBMZB12V/1
10	11–20	XBMZB12V/11
10	21–30	XBMZB12V/21
<b>ZBF12 Tags Vertically Numbered</b>		
10	1–10 ①	XBMZBF12V/1
10	11–20	XBMZBF12V/11
10	21–30	XBMZBF12V/21

**Marking Tags for 16 mm Wide Terminal Blocks**

Standard Pack	Number Sequence	Catalog Number
<b>ZB15 Tags Vertically Numbered</b>		
10	1–10 ①	XBMZB15V/1
10	11–20	XBMZB15V/11
10	21–30	XBMZB15V/21
<b>ZBF15 Tags Vertically Numbered</b>		
10	1–10 ①	XBMZBF15V/1
10	11–20	XBMZBF15V/11
10	21–30	XBMZBF15V/21

**Note**

① For text printed horizontally, change “V” in catalog number to “H.”

#### Pre-Printed Marking Tags

##### Terminal Blocks Marking Tags

The tags are made of white self-extinguishing polyamide 6.6 and the imprint is hot stamped with rubproof black ink.

- White marking strip available preprinted. Strip covers 10 terminals. Marking 1 – 10, 11–20, up to 991–999. Contact Eaton for more options.
- XBMZB5 or XBMZBF5 for terminal blocks 5.2 mm wide
- XBMZB6 or XBMZBF6 for terminal blocks 6.2 mm wide
- XBMZB8 or XBMZBF8 for terminal blocks 8.2 mm wide
- XBMZB10 or XBMZBF10 for terminal blocks 10.2 mm wide
- XBMZB12 or XBMZBF12 for terminal blocks 12 mm wide
- XBMZB15 or XBMZBF15 for terminal blocks 16 mm wide

#### Marking Tag Sizes

**Note:** Marking Tag Sizes are for all catalog numbers starting with given prefix, EXCEPT FUSE TERMINAL Blocks.

#### Proper Marking Tag Size

XBMZB5	XBMZBF5	XBMZB6	XBMZBF6	XBMZB8	XBMZBF8	XBMZB10	XBMZBF10	XBMZB12	XBMZBF12	XBMZB15	XBMZBF15	XBMSSZB
XBUT25	XBPT25 <sup>②</sup>	XBUT4	XBPT4 <sup>②</sup>	XBUT6	XBPT6 <sup>②</sup>	XBUT10	XBPT10 <sup>②</sup>	XBPT16 <sup>①</sup>	XBPT16 <sup>②</sup>	XBUT35	XBPT35 <sup>②</sup>	XBMKLMZ
XBUT4FBE <sup>①</sup>	XBPTT25	XBUTT4	XBPTT4	XBPT6 <sup>①</sup>	XBPT4FBN <sup>②</sup>	XBUT16	—	—	—	XBPT35 <sup>①</sup>	—	—
XBUT6FBN <sup>①</sup>	XBPTK	XB3UKA	XBPT4FBE <sup>②</sup>	XBUK6	XBPT4FSI <sup>②</sup>	XBTK	—	—	—	—	—	—
XBPT25 <sup>①</sup>	XBPU25 <sup>②</sup>	XB3UKF	XBQT25 <sup>③</sup>	XBPT4FSI <sup>①</sup>	—	XBUK50	—	—	—	—	—	—
XBPT4FBE <sup>①</sup>	XBAP ...	XBUT4FBE <sup>②</sup>	XBQT25FBE <sup>③</sup>	—	—	XBUK150	—	—	—	—	—	—
XBPU25 <sup>①</sup>	XBQT15 <sup>③</sup>	XBUT6FBN <sup>②</sup>	XBQU25 <sup>⑤</sup>	—	—	XBUK95	—	—	—	—	—	—
XBQT15 <sup>①</sup>	XBQT15	XBUK10	—	—	—	XBPT10 <sup>①</sup>	—	—	—	—	—	—
XBQT25FBE <sup>④</sup>	XBQU15 <sup>③</sup>	XBUK4	—	—	—	XBMKLMZ <sup>⑤</sup>	—	—	—	—	—	—
XBQU15 <sup>①</sup>	XBMPK15	XBPT4 <sup>①</sup>	—	—	—	—	—	—	—	—	—	—
XBMUK25	XBMPK15	XBPT4FBN <sup>①</sup>	—	—	—	—	—	—	—	—	—	—
—	XBATCP...	XBQT25 <sup>①</sup>	—	—	—	—	—	—	—	—	—	—
—	—	XBQT25FBE <sup>①</sup>	—	—	—	—	—	—	—	—	—	—
—	—	XBQU25 <sup>①</sup>	—	—	—	—	—	—	—	—	—	—
—	—	XBMUK4	—	—	—	—	—	—	—	—	—	—

#### Notes

- ① For center labeling.
- ② For external labeling.
- ③ For center and outside labeling.
- ④ For lever labeling.
- ⑤ Two (2) XBMZB10 tags fit in one (1) XBMKLMZ.

**Marker Strips and Sheets (for use with XBAPLT2006K1 plotter)**

The **XB** Series marking system provides logical and clear identification of the modular terminal blocks and interface modules.

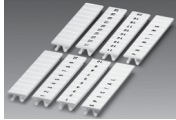
**Product Selection****XBMZB\_****Marker Strips (Strip of 10)**

Terminal Width	Standard Pack	Catalog Number
<b>Blank Strips</b>		
5.2 mm	10	<b>XBMZB5</b>
6.2 mm	10	<b>XBMZB6</b>
8.2 mm	10	<b>XBMZB8</b>
10.2 mm	10	<b>XBMZB10</b>
12 mm	10	<b>XBMZB12</b>
16 mm	10	<b>XBMZB15</b> ①
<b>Flat Strips</b>		
5.2 mm	10	<b>XBMZBF5</b>
6.2 mm	10	<b>XBMZBF6</b>
8.2 mm	10	<b>XBMZBF8</b>
10.2 mm	10	<b>XBMZBF10</b>
12 mm	10	<b>XBMZBF12</b>
16 mm	10	<b>XBMZBF15</b>

**Marker Sheets (Strip of 10)**

Terminal Width)	Color	Std. Pack	Catalog Number
<b>XBMPZB_</b>			
<b>Marker Sheets (10 rows of 12)</b>			
5.2 mm	White	50	<b>XBMPZB5</b>
	Blue	50	<b>XBMPZB5BU</b>
	Red	50	<b>XBMPZB5RD</b>
	Yellow	50	<b>XBMPZB5YE</b>
	Green	50	<b>XBMPZB5GN</b>
<b>Marker Sheets (10 rows of 10)</b>			
6.2 mm	White	50	<b>XBMPZB6</b>
	Blue	50	<b>XBMPZB6BU</b>
	Red	50	<b>XBMPZB6RD</b>
	Yellow	50	<b>XBMPZB6YE</b>
	Green	50	<b>XBMPZB6GN</b>
<b>Flat Marker Sheets (10 rows of 10)</b>			
5.2 mm	White	10	<b>XBMPZBF5</b>
	Orange	10	<b>XBMPZBF5OG</b>
	White	10	<b>XBMPZBF6</b>
	Orange	10	<b>XBMPZBF6OG</b>
	White	10	<b>XBMPZBF8</b>

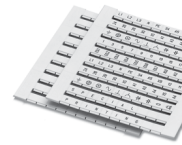
**XBMPZBF\_****Label Sheets for Laser Printers**

The XBM labels have been specially developed for laser printers and have considerable advantages:

- Can be printed on all commercially available laser printers
- Or can use plotter or pen for printing
- Good adhesive properties
- A4 size
- XBMKL25X12WH designed to fit XGBS2512 group marker
- XBMLMAL447 is perforated for terminal strip marker XBMGLMA and is 44 x 7 mm

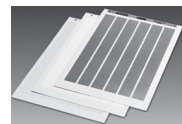
**Product Selection****XBM\_****Label Sheets**

Standard Pack	Catalog Number
10	<b>XBMKL25X12WH</b>
10	<b>XBMLMAL447</b>

**Note**

① All markers are strips of 10, except XBMZB15, which is a strip of 5.

# 42.1

## Terminal Blocks, Fuse Blocks and Fuse Holders

IEC—XB Series

### Terminal Block Group Marking

Terminal block groups are marked using marking labels that are snapped into the marker strip groove of the terminal blocks. The group is marked using either labels or insert markers.

#### Product Selection

XBGBS2512



#### Terminal Block Group Marking <sup>①</sup>

Standard Pack	Catalog Number
100	XBGBS2512

### Insert Markers for Laser Printers

One sheet = 56 labels. Lettering field is 40 x 17 mm.

#### Product Selection

XBMUBEL4017



#### Insert Markers for XBMUBE(D)

Standard Pack	Catalog Number
10	XBMUBEL4017

42

### Terminal Strip Markers

Adjustable height for end bracket labeling.

#### Product Selection

XBM\_



#### Terminal Strip Markers <sup>①</sup>

Standard Pack	Catalog Number
<b>20 x 8 mm Wide</b>	
10	XBMKLM2
<b>44 x 7 mm Wide</b>	
10	XBMGLMA

### Refillable Marker Pen

Refillable marker pen for manual labeling, line thickness 0.35 mm.

#### Product Selection

XBMXPEN



#### Terminal Strip Markers <sup>①</sup>

Standard Pack	Catalog Number
<b>Pen</b>	
1	XBMXPEN
<b>Ink Cartridge</b>	
1	XBMINK

### Terminal Strip Marker Carriers

For labeling terminal groups, for mounting on DIN rail. Lettering field is 40 x 17 mm.

#### Product Selection

XBMUB\_



#### Terminal Strip Marker Carriers

Standard Pack	Catalog Number
10	XBMUBE
10	XBMUBED

### Non-Refillable Marker Pen

For manual labeling, line thickness 0.5 mm.

#### Product Selection

XBMUBE



#### Non-Refillable Marker Pen

Standard Pack	Catalog Number
1	XBMBSTIFT

#### Note

<sup>①</sup> See Page V7-T42-101 for insert labels.

**Marking Plotter**

The automatic Prepare Pen function ensures optimum marking results right from the first character.

**Custom Marking Tag System**

This plotter system uses Windows®-based software to interface with a PC, allowing custom printing on standard terminal blocks marking tags. These standard marking tags provide circuit identification for Eaton DIN rail mount terminal blocks.

Pens can remain in the pen station even for prolonged intervals without drying out.

**Features**

- Enter tag text directly into EMARK software program or import file from AutoCAD or Excel®
- Selectable font sizes, types and colors including common symbols for circuit identification (ground, ~, etc.)
- Various text formatting options including copy, paste, increment functions, text alignment, etc.
- Durable templates allow printing of four different tag sizes at the same time
- Automatic prepare pen function for optimum results

**Technical Data and Specifications****Marking Plotter**

Description	Specification
<b>Plotter</b>	
Plotter type	Flatbed plotter
Maximum plotting surface	440 mm x 296 mm
Maximum material height	10.5 mm
Maximum plotting speed	40 cm/sec
Pen station	Four depots with double sealing
Drive	Two-phase impulse-driven motor
Interfaces	Parallel (Centronics)/USB Level 1.1
<b>Electronics</b>	
Command language	Based on HP-GL 7475A
Data buffer	16 MB
Addressable resolution	0.01 mm
Repeat accuracy	0.05 mm
Repeat accuracy on pen change	0.05 mm with optimum pen
<b>Power Supply</b>	
Power supply	Via separate power supply unit with exchangeable mains feeder cable
Power supply unit input voltage	100–240 Vac/50–60 Hz
Power supply unit input current (maximum)	0.3A at 230V~
Power supply unit output voltage	24 Vdc
Power supply unit output current (maximum)	1.4A
<b>Environmental conditions</b>	
Operation	50° to 95°F (10° to 35°C) 35% to 75% relative humidity
Storage	14° to 122°F (–10° to 50°C) 10% to 90% relative humidity

**Dimensions**

Approximate Dimensions in Inches (mm)

**Marking Plotter**

L	W	H	Approx. Weight In Lbs (kg)
25.98 (660)	17.32 (440)	4.92 (125)	18 (8)

**Marking Plotter**

Description	Standard Pack	Catalog Number
Plotter kit <sup>①</sup>	1	<b>XBAPLT2006K1</b>
Pen station sealing set	1	<b>XBMP1PENDEPOT</b>
Plotter pen preparation plate	1	<b>XBMP1PREPLATES</b>
Template for marker strips	1	<b>XBMP1MZB</b>
Template for flat marker strips	1	<b>XBMP1MZBF</b>
Template for XBMPZB marker sheets	1	<b>XBMP1MPZB</b>
Template for XBMPZBF marker sheets	1	<b>XBMP1MPZBF</b>
Template for Weidmuller multiscard sheet	1	<b>XBMP1MCSF46</b>
Template for Weidmuller multiscard sheet universal	1	<b>XBMP1MCU</b>
Template for Entrelec sheets	1	<b>XBMP1MRC</b>
0.25 mm disposal pen	1	<b>XBMDPEN25R</b>
0.35 mm disposal pen	1	<b>XBMDPEN35R</b>
0.25 mm pen	1	<b>XBMPEN25</b>
0.35 mm pen	1	<b>XBMPEN35</b>
Ink Cartridge	2	<b>XBMINK</b>
Pen cleaning set	1	<b>XBMRSET</b>
Cleaning cartridges	2	<b>XBMRMEKFC2</b>

**EMARK Software**

Eaton's EMARK software makes labeling your terminal blocks quick and simple. You can import your data from ECHART, any other CAD/CAE program, or enter text directly into EMARK. The software allows marking tags to be printed on the PLT2006 plotter in a professional manner.

**Note**

<sup>①</sup> Plotter kit includes PLT2006 plotter system with EMARK software and user manual, starter ink and cleaning sets, and templates for marking all XBMZB and XBMZBF tags.



## Testing Accessories

### Test Adapter

For 4 mm diameter test plug and 4 mm diameter safety test plug. Makes contact in the bridge shaft.

#### Product Selection

XBATSPA14



#### Test Adapter

Standard Pack	Catalog Number
1	XBATSPA14

### Modular Test Plugs

For individual assembly of test plug strips.

#### Product Selection

XBATS\_

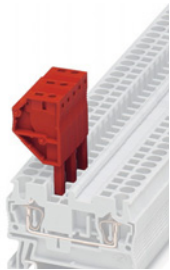

#### Modular Test Plugs

Standard Pack	Catalog Number
<b>Test Plugs</b>	
10	XBATSPS5
10	XBATSPS6
10	XBATSPS8
<b>Spacer Plate</b>	
10	XBATSDPPS5
10	XBATSDPPS6
10	XBATSDPPS8

### Test Plugs

Consisting of metal part for socket hole and insulating sleeve.

#### Product Selection

XBATSM\_



#### Test Plugs

Standard Pack		Catalog Number
<b>2.3 mm</b>		
10	—	XBATSMPSMT
10	Blue	XBATSMPSIHBU
10	White	XBATSMPSIHHW
10	Red	XBATSMPSIHRD
10	Black	XBATSMPSIHBK

XBATSM\_



Standard Pack		Catalog Number
<b>4 mm</b>		
10	—	XBATSPSMT
10	Blue	XBATSPSIHBU
10	White	XBATSPSIHHW
10	Red	XBATSPSIHRD
10	Black	XBATSPSIHBK

## Separating Plates, Covers and Bridges

### End Cover

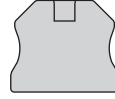

Used to cover an open end of terminal block when changing sizes within an assembly and/or for last terminal block in a row.

### Partition Plate

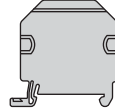

Protrudes over the terminal block and is used to increase electrical clearance between terminals. Also provides visual indications of the functions of terminal blocks. For example, terminal blocks between two partition plates may provide an exact location for test points.

### End Cover Segment



Covers protruding terminal block segments of three- and four-wire terminal blocks when next to a two-wire blocks. This ensures that all is touch-proof and saves space over using a standard end cover.

### Jumper/Bridge

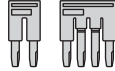

Provides the ability to electrically connect terminal blocks. Non-adjacent blocks may be bridged by snapping off the contact tabs of the standard bridge. The reducing bridge permits simple connection of terminal blocks with different nominal cross-sections.

#### Note

See these accessories as listed with terminal blocks for more information.

# 42.2

## Terminal Blocks, Fuse Blocks and Fuse Holders

### NEMA

NEMA



### Contents

#### Description

#### Page

NEMA

C381 Series Terminal Blocks, Rail Mounted . . .	<b>V7-T42-107</b>
TB Series Terminal Blocks, Modular . . . . .	<b>V7-T42-111</b>

42



### NEMA Overview

#### Product Description

NEMA terminal blocks provide a panel or DIN rail mount block that can be assembled from modular pieces. These blocks accommodate wire from 22 to 1/0 AWG and up to 175A and 600V.

#### Standards and Certifications

- UL File #E67464 and #E56797

## C381 Series Terminal Blocks, Rail Mounted



## Contents

<b>Description</b>	<b>Page</b>
C381 Series Terminal Blocks, Rail Mounted	
Product Selection .....	<b>V7-T42-108</b>
Accessories .....	<b>V7-T42-109</b>
Modifications .....	<b>V7-T42-109</b>
Technical Data and Specifications .....	<b>V7-T42-110</b>
Dimensions .....	<b>V7-T42-110</b>
TB Series Terminal Blocks, Modular .....	<b>V7-T42-111</b>

## C381 Series Terminal Blocks, Rail Mounted

### Product Description

- 600V
- Snap-fit nylon sections
  - Control circuit blocks
  - Power circuit blocks
  - Fuse blocks
  - Switch blocks
- Sections can be interlocked in any quantity and any mixture for direct panel mounting or channel mounting
- Three terminal choices in control circuit blocks, up to 32 circuits per foot
- Power circuit blocks for heavy-duty applications, up to 16 circuits per foot
- Fuse blocks accommodate any 0.406 x 1.5 in (10.3 x 38.1 mm) ferrule type cartridge fuse up to 30A
- Switch blocks have removable blade for extra safety

### Standards and Certifications

- UL File #E67464



### A Typical Mixture of Control Circuit Blocks, Power Blocks, Switch and Fuse Blocks in a Mounting Channel

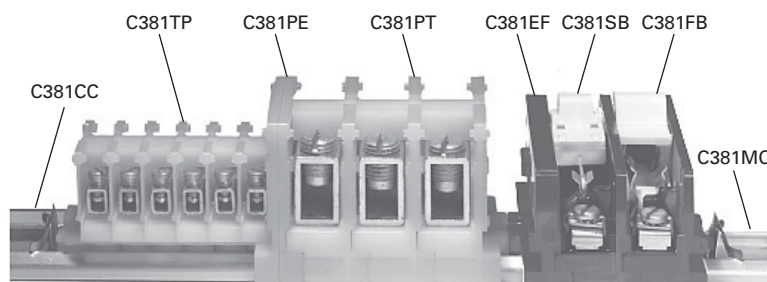

# 42.2

## Terminal Blocks, Fuse Blocks and Fuse Holders

NEMA

### Product Selection

#### When Ordering Specify

Catalog number and quantity, which must be in a multiple of the available minimum standard package.

Examples:









- 200 Cat. No. C381ST
- 20 Cat. No. C381PT
- 100 Cat. No. C381CC

Catalog number and quantity of end sections also in minimum quantity standard package.

Example:

- 25 Cat. No. C381ES.

### Control, Power, Switch and Fuse Blocks <sup>①</sup>

	Description	AWG Wire Size	Standard Pack <sup>②</sup>	Catalog Number
<b>Control Circuit Terminal Blocks—Rated 50A</b>				
	C381ST Type ST (screw terminal)	22–14 AWG	100	C381ST
	C381TP Type TP (tubular pressure plt)	22–10	100	C381TP
	C381TS Type TS (tubular screw) end section	18–8	100	C381TS
	C381ES End section	—	25	C381ES
<b>Power Circuit Terminal Blocks—Rated 155A</b>				
	C381PT Type PT (tubular screw)	10–1/0	10	C381PT
	C381PE End section	—	10	C381PE
<b>Switch Blocks—Rated 15A and Fuse Blocks—Rated 30A</b>				
	C381SB Switch blocks	18–8	10	C381SB
	C381FB Fuse blocks	18–8	10	C381FB
	C381EF End section	—	10	C381EF

#### Notes

- ① Available only in minimum quantity standard packages.
- ② Must be ordered in standard package quantity or in multiples of these quantities.

## Accessories

### C381 Series Terminal Blocks, Rail Mounted <sup>①</sup>

Description	Standard Pack <sup>②</sup>	Catalog Number
Aluminum mounting channel—6 ft (1.8m) lengths	25	<b>C381MC</b>
Screw type channel clamp (one required each end) <sup>③</sup>	100	<b>C381VC</b>
Spring type channel clamp (one required each end) <sup>③</sup>	100	<b>C381CC</b>
Vinyl marking strip—3/8 in x 25 ft (9.5 mm x 7.6m) coil	1	<b>C381MS</b>
Marking paper—pressure sensitive—5/16 x 11-11/16 in (7.9 x 296.9 mm), 24 strips/sheet	5 sheets	<b>C381MP</b>
Marking strip retainer (one required/grouping)		
For use on control circuit blocks	100	<b>C381SR</b>
For use on power circuit blocks	100	<b>C381SP</b>
Fanning strip—for type TP and/or TS	50	<b>C381TF</b>
Fanning strip—for type ST	50	<b>C381SF</b>
Terminal jumper (two-pole) <sup>④</sup>	100	<b>C381TJ</b>
Ganging rod—1/8 in x 6 in (3.2 mm x 152.4 mm) <sup>⑤</sup>	10	<b>C381GR</b>

## Modifications

### Pull Apart Terminal Blocks <sup>①</sup>

Description	AWG Wire Size	Standard Pack <sup>②</sup>	Catalog Number
One-pole stationary section (tubular pressure plt)	22–10	100	<b>C381PS</b>
Three-pole movable section (tubular pressure plt)	22–10	12	<b>C381PM</b>
End section	—	25	<b>C381ES</b>
Polarizing plug (promotes alignment of poles) <sup>⑥</sup>	—	100	<b>C381PP</b>

### Pull Apart Terminal Blocks

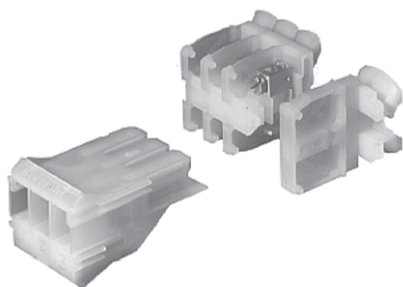

**Illustrates: One–Three-Pole Movable Section, Three–One-Pole Stationary Sections and One–End Piece**

#### Notes

- ① Available only in minimum quantity standard packages.
- ② Must be ordered in standard package quantity or in multiples of these quantities.
- ③ C381CC is a snap-in, one time use disposable type. C381VC can be readjusted or reused as desired.
- ④ For use on adjacent Type TP and/or TS control circuit sections.
- ⑤ May be used on section covers or to gang fuse and/or switch blocks.
- ⑥ L shaped plug installs in end of stationary section, Catalog Number C381PS, and prevents incorrect installation of movable section, Catalog Number C381PM.

#### Technical Data and Specifications

##### Formulas for Calculating Blocks and Channel Lengths

N = Number of Blocks

##### C381 Series Terminal Blocks, Rail Mounted

Description	Blocks Length
Control blocks and pull apart blocks	$0.762 + (0.375 \times N)$
Power circuit blocks	$0.812 + (0.750 \times N)$
Fuse and switch blocks	$0.812 + (0.755 \times N)$
Mounting channel (minimum channel length)	$0.75 + \text{blocks length}$

42

#### Dimensions

Approximate Dimensions in Inches (mm)

##### C381 Series Terminal Blocks, Rail Mounted

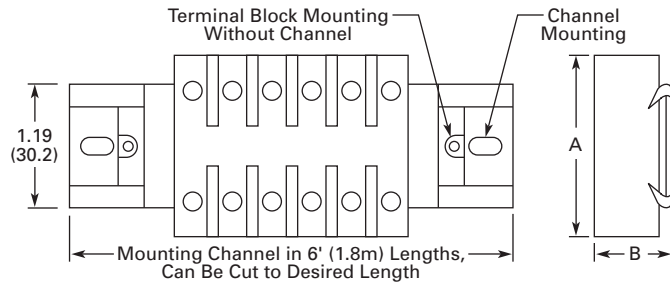

Block	A	B
Control circuit blocks	1.25 (31.8)	1.55 (39.4)
Power circuit blocks	1.75 (44.5)	2.00 (50.8)
Fuse blocks	2.75 (69.9)	2.00 (50.8)
Switch blocks	2.75 (69.9)	2.00 (50.8)
Pull apart blocks	1.88 (47.8)	2.75 (69.9)

## TB Series Terminal Blocks, Modular



## TB Series Terminal Blocks, Modular

## Product Description

TBA and TBD modular terminal blocks are designed to conserve space, while allowing maximum flexibility and ease of installation. Available as one-, two- and three-pole circuits, simple and uniform installation is possible because their design is based on 5/8 in (15.9 mm) modules. Standard blocks are white nylon.

**Breathing Action Clamping Collar**

The unique design of the clamping collar permits the collar to breathe as the wire expands and contracts, maintaining a constant and permanent clamping pressure. This eliminates loose connections resulting from the gradual flattening of conductors and joint deterioration caused by heating and cooling cycles.

## Features

**Blocks—Design Features**

- Compact design permits mounting 48–600V or 90–300V terminals per foot
- Fully shielded construction, 600V spacings
- Nylon construction provides anti-tracking and impact resistance
- TBA types are available in rail mounted, base mounted and power distribution types
- Terminal blocks easily snap on or off mounting rails; not necessary to disturb adjacent units
- No end pieces or backing plates are needed when rail mounting
- A 12 circuit subminiature blocks, rated 20A at 300V, is available for “high density” applications
- Popular blocks are also available in dual mount for use with standard TBA or 35 mm DIN rails

## Contents

<b>Description</b>	<b>Page</b>
C381 Series Terminal Blocks, Rail Mounted . . . . .	<b>V7-T42-107</b>
TB Series Terminal Blocks, Modular	
Product Selection . . . . .	<b>V7-T42-112</b>
Accessories . . . . .	<b>V7-T42-113</b>
Technical Data and Specifications . . . . .	<b>V7-T42-114</b>
Dimensions . . . . .	<b>V7-T42-115</b>

## Standards and Certifications

- UL recognized: File No. E56797
- CE approved

**Terminals—Design Features**

- Insulated walls of lug guide wire into lug
- Blocks are shipped with clamping screw backed out
- Constant locking torque keeps terminal screws in position
- Terminal screws are captive; cannot be lost in shipment or handling
- Hardened stainless steel clamping collar eliminates stripped threads
- Large opening in clamping collar accommodates oversized conductors; smallest collar will accept three 14 AWG stranded conductors

#### Product Selection

#### TBA Modular Terminal Blocks

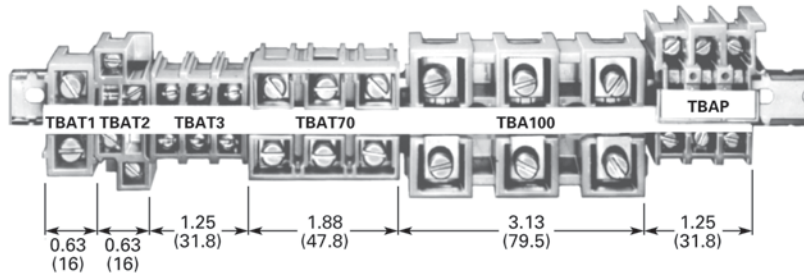

#### Rail and Base Mounted Terminal Blocks

Description	AWG Wire Size	Number of Poles	Ampacity (per Circuit) <sup>①</sup>	Carton Quantity <sup>②</sup>	TBA Rail Catalog Number	DIN Rail <sup>③</sup> Catalog Number
<b>Rail Mounted—600V</b>						
Subminiature blocks	(2) 14–12	12	5A	100	<b>TBDSM12</b> <sup>④</sup>	<b>TBDSM12</b> <sup>④</sup>
Miniature blocks	22–10	4	30A	100	<b>TBDV4</b>	<b>TBDV4</b>
Standard blocks—screw terminals with tang clamping collars	18–2	1	90A	100	—	<b>TBDT1</b>
	22–8	2	40A	100	<b>TBAT2</b>	—
	22–8	3	40A	20	<b>TBAT3-20</b>	<b>TBDT3-20</b>
	18–4	3	90A	100	<b>TBDT70</b>	<b>TBDT70</b>
High current blocks	14–2/0	3	175A	12	<b>TBA100</b> <sup>⑤</sup>	—
Standard blocks—plug-in terminals	22–8	3	40A	20	<b>TBAP</b>	—
	18–4	3	70A	20	<b>TBAP70</b>	—
	14–8	3	40A	20	<b>TBAPL70</b>	—
Panel mount blocks	22–10	3	30A	100	<b>TBAL30</b>	—
	8–4	3	115A	12	<b>TBAL90</b>	—
Disconnect blocks—for 1/4 in (6.4 mm) dia. by 1–1/16 in (25.4–36.5 mm) fuse	22–8	1	30A	50	<b>TBAD</b>	—
Fuse blocks—for 13/32 in (10.3 mm) dia. by 1–1/2 in (38.1 mm) fuse	22–8	1	30A	50	<b>TBDTF</b>	<b>TBDTF</b>
<b>Base Mounted—600V</b>						
Miniature blocks—screw terminals with tang clamping collars	22–10	4	30A (600V)	90	<b>TBBT4</b>	—
Standard blocks—standard screw terminals	22–8	3	40A	80	<b>TBAPT3</b>	—
Universal mounting blocks	8 maximum	4	50A <sup>⑥</sup>	25	<b>TBU4</b>	—
	8 maximum	6	50A <sup>⑥</sup>	60	<b>TBU6</b>	—
	8 maximum	8	50A <sup>⑥</sup>	45	<b>TBU8</b>	—
	8 maximum	12	50A <sup>⑥</sup>	35	<b>TBU12</b>	—

#### Notes

- ① Based on 50°C rise, test at 25°C ambient while using maximum wire size.
- ② Must be ordered in standard package quantity or in multiples of these quantities.
- ③ Dual mounting blocks—mount on either TMR/TBA rail or 35 mm DIN rail.
- ④ May also be mounted on mini-DIN rail (15 mm). Catalog Number C383TS15.
- ⑤ May also be base mounted.
- ⑥ TBU Series = 60A with crimped wire.



**Accessories****TB Series Terminal Blocks, Modular**

Description	Length <sup>①</sup>	Number of Poles	Carton Quantity <sup>②</sup>	Catalog Number
<b>Mounting Rail</b>				
Aluminum	12.5 (317.5)	—	25	<b>TMR12</b>
	37.5 (952.5)	—	25	<b>TMR37</b>
	72.0 (1828.8)	—	25	<b>TBATR72</b>
35 mm DIN—steel	1m	—	20	<b>MC382MA1-20</b>
<b>Marking Strips</b>				
Miniature blocks—TBDV4 and TBBT4	6.0 (152.4)	—	50	<b>TMS6</b>
TBU Series—matte finish	7.5 (190.5)	—	25	<b>TMSU</b>
All other blocks	12.5 (317.5)	—	50	<b>TMS</b>
<b>Jumpers</b>				
TBAT1 and TBAP70	—	2-pole	100	<b>TJ1</b>
TBAT2	—	2-pole	100	<b>TJ2</b>
TBAT3, TBABT3, TBAP and TBBP	—	2-pole	100	<b>TJ3</b>
TBDV4 and TBBT4	—	4-pole	100	<b>TJ4</b>
TBAD and TBATF	—	2-pole	100	<b>TJ5</b>
TBAL30	—	2-pole	100	<b>TJ6</b>
TBU	—	12-pole	10	<b>TJ7</b>
TBDT3	—	2-pole	100	<b>TJ8</b>
<b>Miscellaneous</b>				
End piece for TBABT3 and TBBP	—	—	50	<b>TAD</b>
Lug shield for TBA100 and TBAL90	—	—	50	<b>TAS</b>
Fuse puller	—	—	50	<b>TBP</b>
Lighted fuse puller—blown fuse indication	—	—	25	<b>TBLP</b>

**Notes**

- ① Length in inches (mm) except as noted.  
 ② Must be ordered in standard package quantity or in multiples of these quantities.

#### Technical Data and Specifications

##### TB Series Terminal Blocks, Modular

Description	Specification
Continuous temperature	212°F (100°C)
Tensile strength	10,000–12,000 psi
Impact resistance	2.0 ft-lb/in (arc)
Arc resistance	140 seconds

- Chemical resistance to:
  - Acetone
  - Ammonia gas
  - Benzene
  - Gasoline
  - Mineral oil
  - Sodium bisulfate
  - Sodium chloride
  - Sodium nitrate
  - Water up to 50°C

##### Flashover Voltages

Catalog Number	Vac rms, 60 Hz	
	Opposite Polarity	To Ground
TBAT1	9100	6600
TBAT2	9600	7300
TBAT3	8600	7300

##### Recommended Terminal Tightening Torque

Wire Size	Torque
Up to 8 AWG	20 lb-in
Up to 4 AWG	35 lb-in
Up to 2/0 AWG	50 lb-in

42

To find a current rating, place a straight edge horizontally at the value of anticipated maximum internal panel ambient (scale on the left), and read the current rating for the device on the bottom scale. *Example:* at 60°C, TBAT3 is rated 54 amperes.

Ampere rating is based on maximum allowable temperature—ambient temperature plus temperature rise due to current.

Ratings based on 90°C total temperature of a three-pole block with each pole carrying current and wired with largest size conductors.

#### Temperature Rating

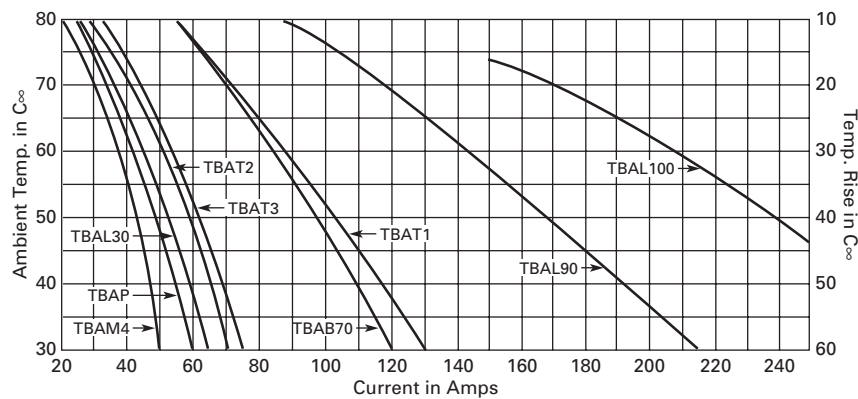

## Dimensions

Approximate Dimensions in Inches (mm)

### TB Series Terminal Blocks, Modular

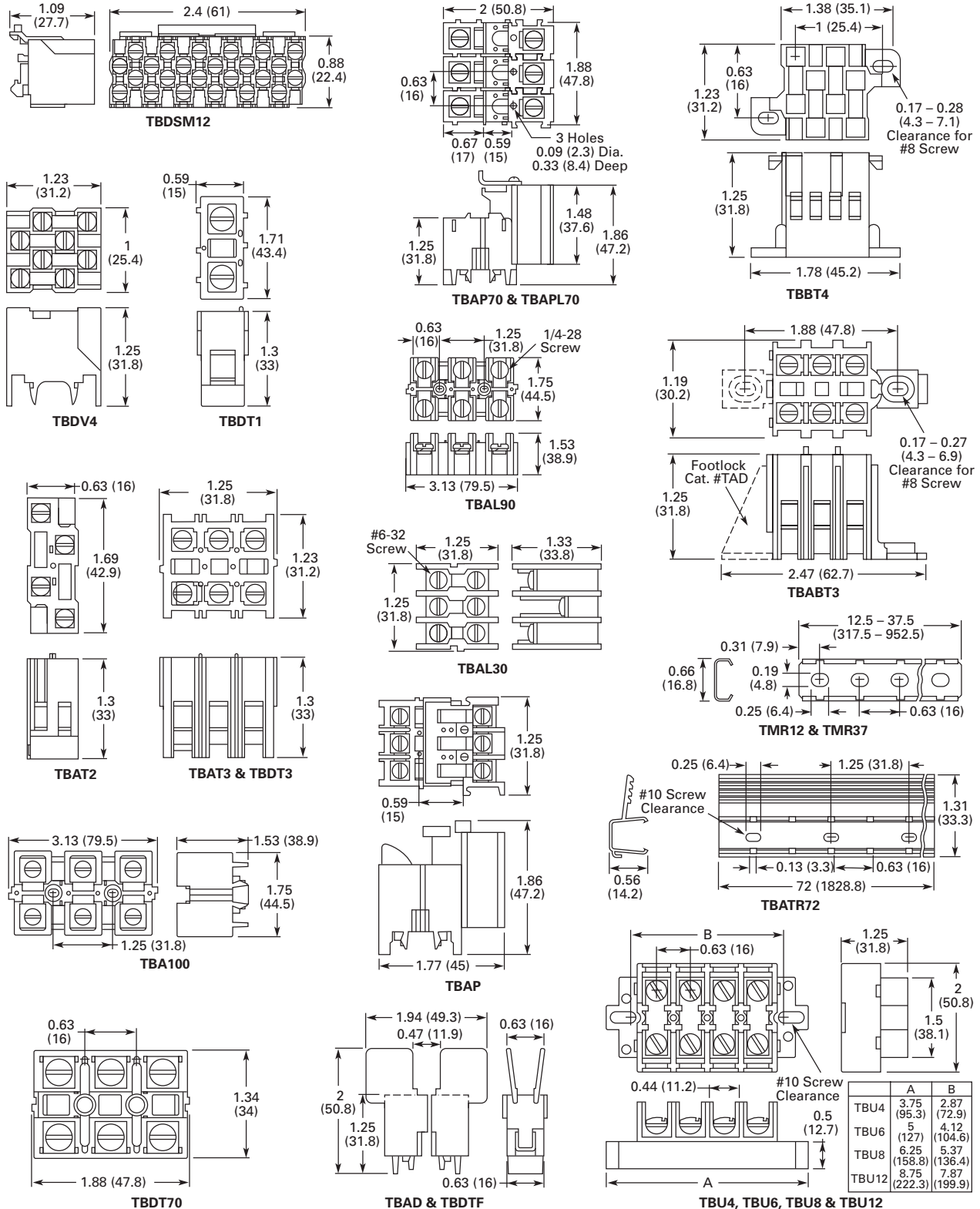

# 42.3

## Terminal Blocks, Fuse Blocks and Fuse Holders

### Power Distribution

#### Power Distribution Products

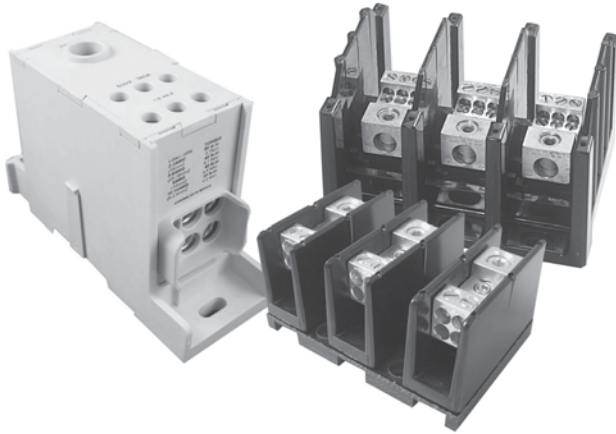

42

#### Contents

<i>Description</i>	<i>Page</i>
Power Distribution	
CHDB Series—Power Distribution Blocks . . . .	<b>V7-T42-117</b>
CH160 Series—Power Terminal Blocks . . . . .	<b>V7-T42-123</b>
Power Terminal Block Accessories . . . . .	<b>V7-T42-126</b>

### Power Distribution Overview

#### Product Selection Guide

Series	Current Range	UL Certification	High Short Circuit Current Rating <sup>①</sup>	UL 508A Approved for Industrial Control Panels		
				Branch Circuits	Feeder Circuits	HVAC UL 1995
<b>CH162</b>	115–175A	UL 1059 Recognized	No	Yes	No <sup>②</sup>	Yes
<b>CH163</b>	175–420A	UL 1059 Recognized	No	Yes	No <sup>②</sup>	Yes
<b>CH165</b>	620–840A	UL 1059 Recognized	No	Yes	No <sup>②</sup>	Yes
<b>CHDB</b>	175–570A	UL 1953 Listed	Yes	Yes	Yes	Yes

#### Notes

- ① Refer to **Page V7-T42-118** to determine short circuit current ratings with fuses and **Pages V7-T42-119** and **V7-T42-120** to determine short circuit current ratings in conjunction with specific Eaton circuit breakers.
- ② Single-pole units, when installed with proper spacings, may meet requirements for UL 508A feeder circuits.

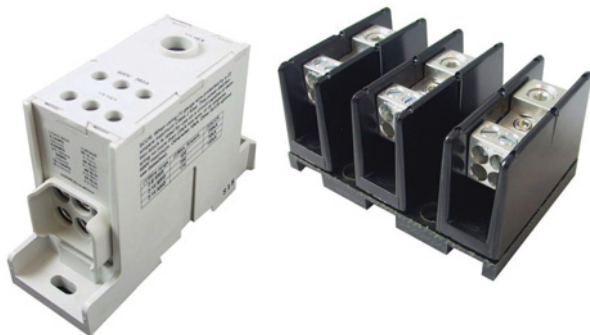
**CHDB Series—Power Distribution Blocks, Enclosed and Open****Contents**

<b>Description</b>	<b>Page</b>
CHDB Series—Power Distribution Blocks	
Product Selection . . . . .	<b>V7-T42-118</b>
Technical Data and Specifications . . . . .	<b>V7-T42-118</b>
Dimensions . . . . .	<b>V7-T42-121</b>
CH160 Series—Power Terminal Blocks . . . . .	<b>V7-T42-123</b>
Power Terminal Block Accessories . . . . .	<b>V7-T42-126</b>

**CHDB Series—Power Distribution Blocks****Product Description**

Eaton's CHDB Series of Power Distribution Blocks was designed for high short circuit current rating (SCCR) applications up to 200,000 amperes. They are assembled with the minimum spacing to meet UL 1953 requirements for feeder circuits in UL 508A industrial control panels, and provide significant wiring flexibility.

Available in three-pole open style and single-pole enclosed style with a variety of terminal arrangements and current-carrying capability up to 570 amperes.

**Features and Benefits****Enclosed Style**

- IP20 finger-safe enclosure
- 600 Vac or Vdc (UL 1953), 690 Vac or Vdc
- DIN rail or panel mount
- Captive termination screws prevent lost screws
- Single-pole, gang mountable for multi-pole applications
- Tin plated Al connections suitable for Cu conductors
- Flammability, UL 94V-0

**Open Style**

- 600 Vac or Vdc (UL 1953)
- Panel mount
- Three-pole open design for easy wiring
- Tin-plated Al connections suitable for Cu conductors
- Flammability, UL 94V-0
- Available covers for additional protection (does not meet IP20)











**Standards and Certifications**

- UL Listed 1953, Guide QPOS, File E256146
- CSA Certified, Class 6228-01, File 15364 (enclosed style)
- CE Component IEC 60947-7-1 (enclosed style)
- IEC 60529, IP20 (finger-safe) under specific wiring conditions (enclosed style)



#### Product Selection

#### CHDB Series—Power Distribution Blocks

	Line Connection	Load Connection	Configuration	Amperes	Style	Poles	Catalog Number
	2/0-#8 AWG	(4) #4-#14 AWG		175	Open	3	<b>CHDB2203</b>
	2/0-#8 AWG	(6) #4-#14 AWG		175	Open	3	<b>CHDB3213</b>
	300 kcmil-#4 AWG	(6) #4-#12 AWG		310	Open	3	<b>CHDB3233</b>
	300 kcmil-#4 AWG	(12) #4-#14 AWG		310	Open	3	<b>CHDB3703</b>
	300 kcmil-#4 AWG	(6) #2-#12 AWG (3) 1/0-#12 AWG		310 310	Open Open	3 3	<b>CHDB3713</b> <b>CHDB3713</b>
	2/0-#8 AWG	2/0-#8 AWG		175	Enclosed ①	1	<b>CHDB204F</b>
	500 kcmil-#6 AWG	(6) #2-#14 AWG		380	Enclosed ①	1	<b>CHDB330F</b>
	300 kcmil-#4 AWG	(12) #4-#14 AWG		570	Enclosed ①	1	<b>CHDB377F</b>

#### Technical Data and Specifications







































#### Power Terminal Block Short-Circuit Current Ratings (SCCR) with Fuses

Catalog Number	Terminal Copper Conductors		Maximum Fuse Class and Amperes				SCCR (kA)
	Line	Load	J LPJ	T JJS/JJN	RK-1 LPS-RK/LPN-RK	RK-5 FRS-R/FRN-R	
<b>CHDB2203</b>	2/0-#8 AWG	#4-#12 AWG	200	200	200	60	200
		#4-#14 AWG	175	175	100	60	100
			200	200	100	60	50
<b>CHDB3213</b>	2/0-#8 AWG	#4-#12 AWG	400	400	200	100	200
			400	400	400	100	100
		#4-#14 AWG	175	175	100	60	100
<b>CHDB3233</b>	300 kcmil-#4 AWG	#4-#8 AWG	400	400	200	100	200
			400	400	400	100	100
		#4-#12 AWG	175	175	100	60	100
<b>CHDB3703</b>	300 kcmil-#4 AWG	#4-#8 AWG	400	400	200	100	200
		#4-#14 AWG	400	400	400	100	100
			175	175	100	60	100
<b>CHDB3713</b>	300 kcmil-#4 AWG	1/0-#6 AWG	400	400	200	100	200
		#4-#12 AWG	400	400	400	100	100
			175	175	100	60	100
<b>CHDB204F</b>	2/0-#8 AWG	2/0-#8 AWG	200	200	100	60	200
<b>CHDB330F</b>	500 kcmil-#6 AWG	#2-#6 AWG	400	400	200	100	200
		#2-#14 AWG	200	200	100	30	50
			175	175	100	30	100
<b>CHDB377F</b>	300 kcmil	#4-#8 AWG	600	600	400	200	200
	300 kcmil-#4 AWG	#4 AWG	600	600	400	200	50
		#4-#14 AWG	200	200	100	30	50

**Note**

① Finger-safe.

## Power Terminal Block Short-Circuit Ratings (SCCR) for UL 508A Applications with Circuit Breakers

Catalog Number	Description	Enclosure Size in Inches (mm)	Current Rating	Opening per Pole		Line Conductors Cu	Load Conductors Cu	SCCR @ 480V (Load Side)	Eaton Breaker	Available Breaker Current Ratings
				Line	Load					
CHDB2203	Feeder Listed Open PDB	16.00 x 16.00 x 6.75 (406.4 x 406.4 x 171.5)	175			2/0-#8	#4-#10 #12 #14	18 kA 18 kA 14 kA	EGB125	15, 20, 25, 30, 35, 40, 45, 50, 60, 70, 80, 90, 100, 125
CHDB2203	Feeder Listed Open PDB	16.00 x 16.00 x 6.75 (406.4 x 406.4 x 171.5)	175			2/0-#8	#4-#10 #12 #14	25 kA 22 kA 14 kA	EGE125	15, 20, 25, 30, 35, 40, 45, 50, 60, 70, 80, 90, 100, 125
CHDB2203	Feeder Listed Open PDB	16.00 x 16.00 x 6.75 (406.4 x 406.4 x 171.5)	175			2/0-#8	#4-#10 #12 #14	50 kA 22 kA 14 kA	EGS125	15, 20, 25, 30, 35, 40, 45, 50, 60, 70, 80, 90, 100, 125
CHDB2203	Feeder Listed Open PDB	16.00 x 16.00 x 6.75 (406.4 x 406.4 x 171.5)	175			2/0-#8	#4-#10 #12 #14	65 kA 22 kA 14 kA	EGH125	15, 20, 25, 30, 35, 40, 45, 50, 60, 70, 80, 90, 100, 125
CHDB2203	Feeder Listed Open PDB	16.00 x 16.00 x 6.75 (406.4 x 406.4 x 171.5)	175			2/0-#8	#4-#10 #12 #14	65 kA 22 kA 14 kA	EGC125 <sup>①</sup>	15, 20, 25, 30, 35, 40, 45, 50, 60, 70, 80, 90, 100, 125
CHDB3213	Feeder Listed Open PDB	24.00 x 20.00 x 6.75 (609.6 x 508.0 x 171.5)	175			2/0-#8	#4-#10 #12 #14	18 kA 18 kA 18 kA	EGB125	15, 20, 25, 30, 35, 40, 45, 50, 60, 70, 80, 90, 100, 125
CHDB3213	Feeder Listed Open PDB	24.00 x 20.00 x 6.75 (609.6 x 508.0 x 171.5)	175			2/0-#8	#4-#10 #12 #14	25 kA 22 kA 18 kA	EGE125	15, 20, 25, 30, 35, 40, 45, 50, 60, 70, 80, 90, 100, 125
CHDB3213	Feeder Listed Open PDB	24.00 x 20.00 x 6.75 (609.6 x 508.0 x 171.5)	175			2/0-#8	#4-#10 #12 #14	50 kA 22 kA 18 kA	EGS125	15, 20, 25, 30, 35, 40, 45, 50, 60, 70, 80, 90, 100, 125
CHDB3213	Feeder Listed Open PDB	24.00 x 20.00 x 6.75 (609.6 x 508.0 x 171.5)	175			2/0-#8	#4-#10 #12 #14	65 kA 22 kA 18 kA	EGH125	15, 20, 25, 30, 35, 40, 45, 50, 60, 70, 80, 90, 100, 125
CHDB3213	Feeder Listed Open PDB	24.00 x 20.00 x 6.75 (609.6 x 508.0 x 171.5)	175			2/0-#8	#4-#10 #12 #14	65 kA 22 kA 18 kA	EGC125 <sup>①</sup>	15, 20, 25, 30, 35, 40, 45, 50, 60, 70, 80, 90, 100, 125
CHDB204F	Feeder Listed Enclosed PDB	16.00 x 16.00 x 6.75 (406.4 x 406.4 x 171.5)	175			2/0-#8	2/0-#8	18 kA	EGB125	15, 20, 25, 30, 35, 40, 45, 50, 60, 70, 80, 90, 100, 125
CHDB204F	Feeder Listed Enclosed PDB	16.00 x 16.00 x 6.75 (406.4 x 406.4 x 171.5)	175			2/0-#8	2/0-#8	25 kA	EGE125	15, 20, 25, 30, 35, 40, 45, 50, 60, 70, 80, 90, 100, 125
CHDB204F	Feeder Listed Enclosed PDB	16.00 x 16.00 x 6.75 (406.4 x 406.4 x 171.5)	175			2/0-#8	2/0-#8	35 kA	EGS125	15, 20, 25, 30, 35, 40, 45, 50, 60, 70, 80, 90, 100, 125
CHDB204F	Feeder Listed Enclosed PDB	16.00 x 16.00 x 6.75 (406.4 x 406.4 x 171.5)	175			2/0-#8	2/0-#8	65 kA	EGH125	15, 20, 25, 30, 35, 40, 45, 50, 60, 70, 80, 90, 100, 125
CHDB204F	Feeder Listed Enclosed PDB	16.00 x 16.00 x 6.75 (406.4 x 406.4 x 171.5)	175			2/0-#8	2/0-#8	65 kA	EGC125 <sup>①</sup>	15, 20, 25, 30, 35, 40, 45, 50, 60, 70, 80, 90, 100, 125
CHDB3233	Feeder Listed Open PDB	24.00 x 20.00 x 6.75 (609.6 x 508.0 x 171.5)	310			350 kmil-#4	#4-#6 #8 #10	25 kA 25 kA 14 kA	JGE250	70, 90, 100, 125, 150, 175, 200, 225, 250
CHDB3233	Feeder Listed Open PDB	24.00 x 20.00 x 6.75 (609.6 x 508.0 x 171.5)	310			350 kmil-#4	#4-#6 #8 #10	35 kA 35 kA 14 kA	JGS250	70, 90, 100, 125, 150, 175, 200, 225, 250
CHDB3233	Feeder Listed Open PDB	24.00 x 20.00 x 6.75 (609.6 x 508.0 x 171.5)	310			350 kmil-#4	#4-#6 #8 #10	65 kA 42 kA 14 kA	JGH250	70, 90, 100, 125, 150, 175, 200, 225, 250
CHDB3233	Feeder Listed Open PDB	24.00 x 20.00 x 6.75 (609.6 x 508.0 x 171.5)	310			350 kmil-#4	#4-#6 #8 #10	65 kA 42 kA 25 kA	JGC250 <sup>①</sup>	70, 90, 100, 125, 150, 175, 200, 225, 250

**Note**

① This breaker frame is marked current limiting and suitable for use as current limiting per UL 508A SB.4.3.2.

#### Power Terminal Block Short-Circuit Ratings (SCCR) for UL 508A Applications with Circuit Breakers, continued

Catalog Number	Description	Enclosure Size in Inches (mm)	Current Rating	Opening per Pole		Line Conductors Cu	Load Conductors Cu	SCCR at 480V (Load Side)	Eaton Breaker	Available Breaker Current Ratings
				Line	Load					
CHDB3703	Feeder Listed Open PDB	24.00 x 20.00 x 6.75 (609.6 x 508.0 x 171.5)	310			350 kmil-#4	#4-#6 #8 #10	25 kA 25 kA 14 kA	JGE250	70, 90, 100, 125, 150, 175, 200, 225, 250
CHDB3703	Feeder Listed Open PDB	24.00 x 20.00 x 6.75 (609.6 x 508.0 x 171.5)	310			350 kmil-#4	#4-#6 #8 #10	35 kA 35 kA 14 kA	JGS250	70, 90, 100, 125, 150, 175, 200, 225, 250
CHDB3703	Feeder Listed Open PDB	24.00 x 20.00 x 6.75 (609.6 x 508.0 x 171.5)	310			350 kmil-#4	#4-#6 #8 #10	65 kA 42 kA 14 kA	JGH250	70, 90, 100, 125, 150, 175, 200, 225, 250
CHDB3703	Feeder Listed Open PDB	24.00 x 20.00 x 6.75 (609.6 x 508.0 x 171.5)	310			350 kmil-#4	#4-#6 #8 #10	65 kA 42 kA 25 kA	JGC250 ①	70, 90, 100, 125, 150, 175, 200, 225, 250
CHDB3713	Feeder Listed Open PDB	24.00 x 20.00 x 6.75 (609.6 x 508.0 x 171.5)	310			350 kmil-#4	#4-#6 #8 #10	25 kA 25 kA 14 kA	JGE250	70, 90, 100, 125, 150, 175, 200, 225, 250
CHDB3713	Feeder Listed Open PDB	24.00 x 20.00 x 6.75 (609.6 x 508.0 x 171.5)	310			350 kmil-#4	#4-#6 #8 #10	35 kA 35 kA 14 kA	JGS250	70, 90, 100, 125, 150, 175, 200, 225, 250
CHDB3713	Feeder Listed Open PDB	24.00 x 20.00 x 6.75 (609.6 x 508.0 x 171.5)	310			350 kmil-#4	#4-#6 #8 #10	50 kA 42 kA 14 kA	JGH250	70, 90, 100, 125, 150, 175, 200, 225, 250
CHDB3713	Feeder Listed Open PDB	24.00 x 20.00 x 6.75 (609.6 x 508.0 x 171.5)	310			350 kmil-#4	#4-#6 #8 #10	65 kA 50 kA 25 kA	JGC250 ①	70, 90, 100, 125, 150, 175, 200, 225, 250
CHDB330F	Feeder Listed Enclosed PDB	24.00 x 20.00 x 6.75 (609.6 x 508.0 x 171.5)	380			500 kmil-#3	#2-#8	14 kA	LGE400	250, 300, 350, 400
CHDB330F	Feeder Listed Enclosed PDB	24.00 x 20.00 x 6.75 (609.6 x 508.0 x 171.5)	380			500 kmil-#3	#2-#8	14 kA	LGS400	250, 300, 350, 400
CHDB330F	Feeder Listed Enclosed PDB	24.00 x 20.00 x 6.75 (609.6 x 508.0 x 171.5)	380			500 kmil-#3	#2-#8	14 kA	LGH400	250, 300, 350, 400
CHDB330F	Feeder Listed Enclosed PDB	24.00 x 20.00 x 6.75 (609.6 x 508.0 x 171.5)	380			500 kmil-#3	#2-#8	25 kA	LGC400 ①	250, 300, 350, 400
CHDB377F	Feeder Listed Enclosed PDB	24.00 x 20.00 x 6.75 (609.6 x 508.0 x 171.5)	570			(2) 300 kmil-#2	#4 #6 #8	30 kA 18 kA 14 kA	LGE600	250, 300, 350, 400, 500, 600
CHDB377F	Feeder Listed Enclosed PDB	24.00 x 20.00 x 6.75 (609.6 x 508.0 x 171.5)	570			(2) 300 kmil-#2	#4 #6 #8	30 kA 18 kA 14 kA	LGS600	250, 300, 350, 400, 500, 600
CHDB377F	Feeder Listed Enclosed PDB	24.00 x 20.00 x 6.75 (609.6 x 508.0 x 171.5)	570			(2) 300 kmil-#2	#4 #6 #8	30 kA 18 kA 14 kA	LGH600	250, 300, 350, 400, 500, 600
CHDB377F	Feeder Listed Enclosed PDB	24.00 x 20.00 x 6.75 (609.6 x 508.0 x 171.5)	570			(2) 300 kmil-#2	#4 #6 #8	42 kA 35 kA 14 kA	LGC600 ①	250, 300, 350, 400, 500, 600

**Note**

① This breaker frame is marked current limiting and suitable for use as current limiting per UL 508A SB.4.3.2.





# 42.3

## Terminal Blocks, Fuse Blocks and Fuse Holders

### Power Distribution

Approximate Dimensions in Inches (mm)

#### CHDB330F

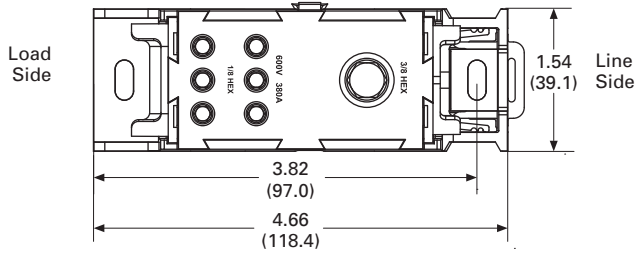

#### CHDB377F

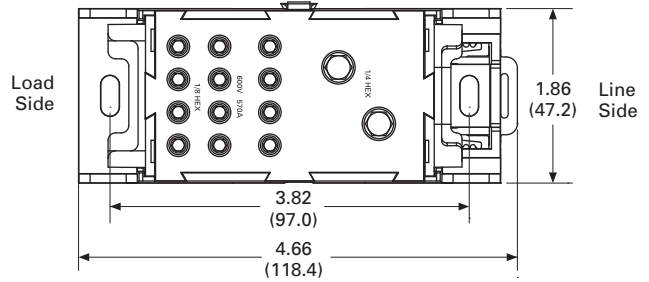

42

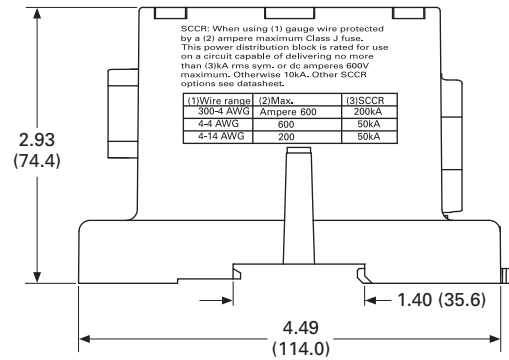
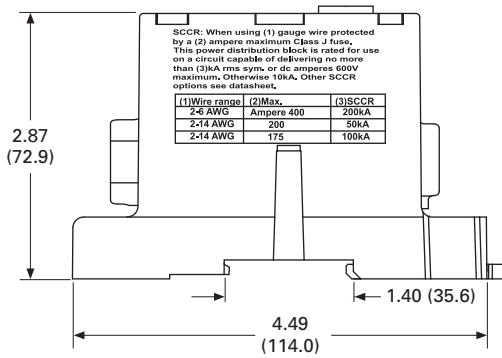

**CH160 Series—Power Terminal Blocks****Contents**

<b>Description</b>	<b>Page</b>
CHDB Series—Power Distribution Blocks . . . . .	<b>V7-T42-117</b>
CH160 Series—Power Terminal Blocks	
Product Selection . . . . .	<b>V7-T42-124</b>
Technical Data and Specifications . . . . .	<b>V7-T42-125</b>
Dimensions . . . . .	<b>V7-T42-125</b>
Power Terminal Block Accessories . . . . .	<b>V7-T42-126</b>

**CH160 Series—Power Terminal Blocks****Product Description**

The CH160 Series of Power Terminal Blocks are UL 1059 recognized power terminal blocks for branch circuit applications. All short circuit current ratings (SCCR) are 10 kA per UL 508A Table SB4.1. The blocks are available in a wide variety of wiring configurations, providing excellent flexibility.

**Features and Benefits**

- Ratings: To 840A, 600V
- Materials
  - Molded material; black, UL rated 94V-0 thermoplastic
- Operating temperature: 302°F (150°C)
- Optional cover:  
See **Page V7-T42-125**

**Standards and Certifications**

- UL Recognized
- CSA Certified



## Product Selection

### When Ordering, Specify

- Catalog number
- Number of poles (up to three-pole available)

### CH160 Power Terminal Blocks—CH162 Series

Line Connection	Load Connection	Connector Material and Ampacity	Catalog Number <sup>①</sup>
#2-#14 Cu/#8 Al	#2-#14 Cu/#8 Al	Al 115A	CH16200_
1/0-#14 Cu	1/0-#14 Cu	Cu 150A	CH16201_
2/0-#8 Cu/Al	2/0-#8 Cu/Al	Al 175A	CH16204_
2/0-#14 Cu/#8 Al	(4) #4-#14 Cu/#8 Al	Al 175A	CH16220_

### CH160 Power Terminal Blocks—CH163 Series

Line Connection	Load Connection	Connector Material and Ampacity	Catalog Number <sup>①</sup>
250 kcmil-#6 Cu	250 kcmil-#6 Cu	Cu 255A	CH16301_
350 kcmil-#6 Cu/Al	350 kcmil-#6 Cu/Al	Al 310A	CH16303_
500 kcmil-#6 Cu/Al	500 kcmil-#6 Cu/Al	Al 380A	CH16306_
2/0-#14 Cu/Al	(6) #4-#14 Cu/#8 Al	Al 175A	CH16321_
350 kcmil-#6 Cu/Al	(6) #4-#14 Cu/#8 Al	Al 310A	CH16323_
(2) 2/0-#14 Cu/#8 Al	(6) #4-#14 Cu/#8 Al	Al 350A	CH16325_
500 kcmil-#6 Cu/Al	(6) #2-#14 Cu/#8 Al	Al 380A	CH16330_
350 kcmil-#6 Cu/Al	(3) #2-#14 Cu/#8 Al	Al 310A	CH16332_
	(2) 1/0-#14 Cu/#8 Al	Al 310A	CH16332_
350 kcmil-#6 Cu/Al	(12) #4-#14 Cu/#8 Al	Al 310A	CH16370_
350 kcmil-#6 Cu/Al	(6) #2-#14 Cu/#8 Al	Al 310A	CH16371_
	(3) 1/0-#14 Cu/#8 Al	Al 310A	CH16371_
350 kcmil-#6 Cu/Al	(21) #10-#14 Cu/#10 Al	Al 310A	CH16372_
350 kcmil-#6 Cu/Al	(3) 1/0-#14 Cu/#8 Al	Al 310A	CH16373_
	(14) #10-#14 Cu/#8 Al	Al 310A	CH16373_
600 kcmil-#2 Cu/Al	(12) #4-#14 Cu/#8 Al	Al 420A	CH16375_
600 kcmil-#2 Cu/Al	(6) #2-#14 Cu/#8 Al	Al 420A	CH16376_
	(3) 1/0-#14 Cu/#8 Al	Al 420A	CH16376_

### CH160 Power Terminal Blocks—CH165 Series

Line Connection	Load Connection	Connector Material and Ampacity	Catalog Number <sup>①</sup>
(2) 350 kcmil-4 Cu/Al	(2) 350 kcmil-4 Cu/Al	Al 620A	CH16500_
(2) 500 kcmil-#6 Cu/Al	(2) 500 kcmil-#6 Cu/Al	Al 760A	CH16504_
(2) 600 kcmil-#2 Cu/Al	(4) 3/0-#8 Cu/Al	Al 840A	CH16528_
	(4) #4-#14 Cu/#8 Al	Al 840A	CH16528_
(2) 500 kcmil-#6 Cu/Al	(12) #4-#14 Cu/#8 Al	Al 760A	CH16530_

#### Note

- <sup>①</sup> Incomplete catalog number—add code suffix **-1**, **-2**, **-3** for number of poles.  
Example: For a 150A 1/0-#14 Cu to 1/0-#14 Cu three-pole PDB, order CH16201-3.

## Technical Data and Specifications

### CH160 Power Terminal Blocks

Description	Specification
Ratings	To 840A, 600V
Materials	Molded material; black, UL rated 94V-0 thermoplastic
Operating temperature	302°F (150°C)

**Note:** For optional cover, see Power Terminal Block Accessories, **Page V7-T42-126**.

## Dimensions

Approximate Dimensions in Inches (mm)

### Series CH163 (Single-, Two- and Three-Pole Available)

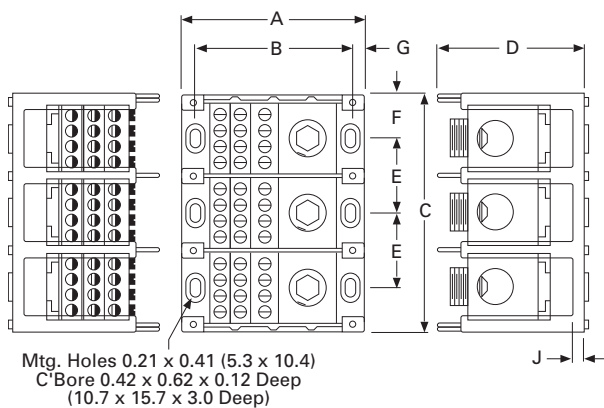

### Series CH162 and CH165 (Single-, Two- and Three-Pole Available)

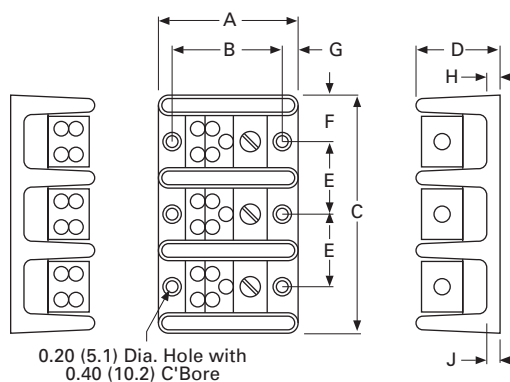

## CH160 Power Terminal Block Dimensions

Series	A	B	C			D	E4	F	G	H	J
			Single-Pole	Two-Pole	Three-Pole						
CH162	2.87 (72.9)	2.25 (57.2)	1.06 (26.9)	1.87 (47.5)	2.68 (68.1)	1.75 (44.5)	0.81 (20.6)	0.53 (13.5)	0.31 (7.9)	0.84 (21.3)	0.31 (7.9)
CH163	4.00 (101.6)	3.37 (85.6)	1.96 (49.8)	3.58 (90.9)	5.20 (132.1)	3.32 (84.3)	1.62 (41.1)	0.97 (24.6)	0.31 (7.9)	0.87 (22.1)	0.35 (8.9)
CH165	5.50 (139.7)	4.75 (120.7)	3.12 (79.2)	5.81 (147.6)	8.50 (215.9)	3.12 (79.2)	2.68 (68.1)	1.56 (39.6)	0.37 (9.4)	1.37 (34.8)	0.62 (15.7)

#### Power Terminal Block Accessories



42

#### Contents

<i>Description</i>	<i>Page</i>
CHDB Series—Power Distribution Blocks . . . . .	V7-T42-117
CH160 Series—Power Terminal Blocks . . . . .	V7-T42-123
Power Terminal Block Accessories	
Technical Data and Specifications . . . . .	V7-T42-127
Dimensions . . . . .	V7-T42-127

### Power Terminal Block Accessories

#### Product Description

##### Protective Cover

- Guards against accidental contact
- Clear with write-on surface for field termination identification
- Available in single-, two- and three-pole

#### Standards and Certifications

##### TB Series Power Blocks

- Contact Eaton for the latest UL 508A short circuit ratings on terminal blocks
- UL Recognized: File No. E62622
- CSA Certified: File No. LR15364



#### Product Selection

##### When Ordering, Specify

- Catalog number

#### CH163 Series Cover

Description	Catalog Number
Single-pole cover	CHCPDB-1 ①
Two-pole cover	CHCPDB-2 ①
Three-pole cover	CHCPDB-3 ①

#### TB Series Power Blocks

Line Connection	Load Connection	Catalog Number
#300 kcmil-#6 Cu/Al	(6) #6-#14 Cu/#8Al	TBAN63

##### Note

① Standard pack, five pieces.

## Technical Data and Specifications

### TB Series Power Blocks

Description	Specification
Ratings	285A, 600V; UL/CSA
Materials	Molded material; black, UL rated 94V-2 thermoplastic
Operating temperature	257°F (125°C)

## Dimensions

Approximate Dimensions in Inches (mm)

### CH163 Series Cover

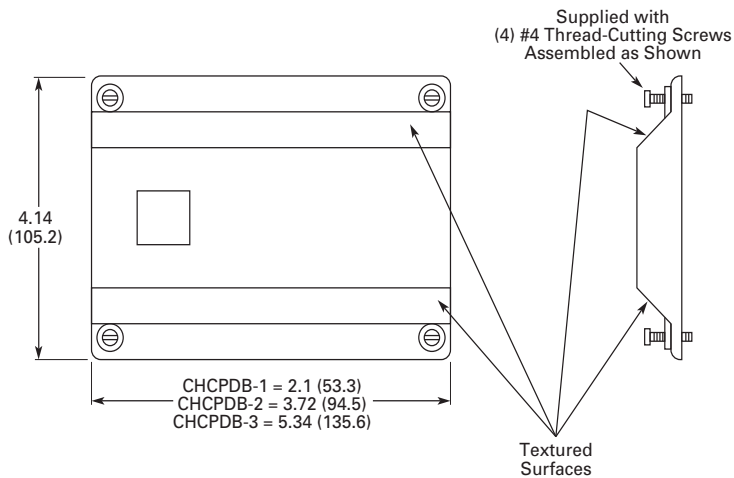

### TB Series Power Blocks

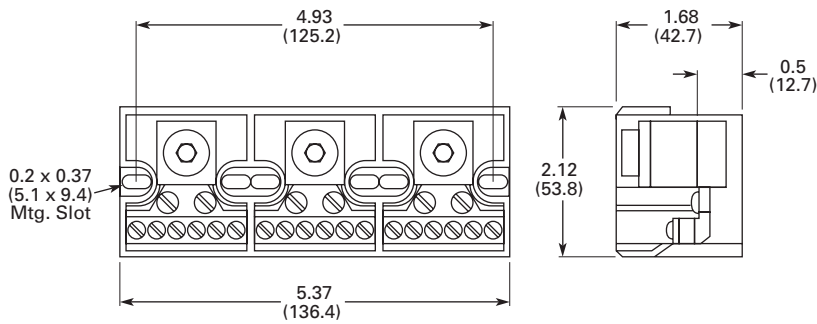

# 42.4

## Terminal Blocks, Fuse Blocks and Fuse Holders

### Fuse Blocks and Fuse Holders

Fuse Blocks and Fuse Holders



42

### Contents

#### Description

#### Page

Fuse Blocks and Fuse Holders	
C383 Series Disconnect Fuse Holders . . . . .	<b>V7-T42-129</b>
C350 Series Fuse Blocks and W Series Fuse Holders . . . . .	<b>V7-T42-131</b>

### Fuse Blocks and Fuse Holders Overview

#### Product Description

Available in compact finger safe (C383) and an open (C350) design. Eaton's fuse blocks and holders provide a simple DIN mounting device for protection in control circuits.

#### Application Description

Fuse holders and blocks available for Class CC, midget, H, M and R.

#### Standards and Certifications

- UL listed
- CSA certified (may not apply to all styles)





**C383 Series Fuse Holders****Contents**

<b>Description</b>	<b>Page</b>
C383 Series Disconnect Fuse Holders	
Product Selection .....	<b>V7-T42-130</b>
Accessories .....	<b>V7-T42-130</b>
Technical Data and Specifications .....	<b>V7-T42-130</b>
Dimensions .....	<b>V7-T42-130</b>
C350 Series Fuse Blocks and W Series Fuse Holders .....	<b>V7-T42-131</b>

**C383 Series Disconnect Fuse Holders****Product Description**

Eaton's C383 Series disconnect fuse holders offer 600V fused circuit protection and subsequently "no load" switching.

These compact disconnects are designed as components in switchboards, panels and control consoles where positive and safe circuit protection is required and where space is at a premium.

The C383 fuse holders mount directly on standard TS35 DIN rails.

**Features**

- "Finger-Safe" design— Recessed termination screws and a fuse extraction door afford you IP20 grade protection and qualify as "finger-safe" per IEC standards
- Easy to adjust position on rail—Simply unlatch the DIN rail adapter, slide the holder to desired position and relock
- Quick change of fuse— A permanently attached pivoting fuse door simplifies and speeds fuse extraction. No tools or accessories needed
- Class CC model is UL listed and CSA certified for branch circuit protection. Midget models are UL Recognized and CSA certified for supplementary and high-speed protection
- Runs cool—The vented design provides adequate air flow around the holders at all times
- Self-extinguishing UL 94-VO rated polyester material

**Standards and Certifications**

Rated voltage:

- CSA/UL: 600 Vac/Vdc, 30A
- IEC (midget only): 690 Vac, 32A



# 42.4

## Terminal Blocks, Fuse Blocks and Fuse Holders

### Fuse Blocks and Fuse Holders

#### Product Selection

C383FH\_



#### Disconnect Fuse Holders

Description	Standard Pack	Catalog Number
<b>For Class CC Fuse</b>		
Single-pole fuse holder	12	C383FHCC
<b>For Midget Fuse (1-1/2 in x 13/32 in)</b>		
Single-pole fuse holder	12	C383FHMD

## 42

#### Accessories

##### Disconnect Fuse Holders

Description	Standard Pack	Catalog Number
<b>Midget or Class CC Fuse Holder</b>		
Multi-pole connection links	100	C383MPCL
Multi-pole handle pins	100	C383MPHP

##### Accessory Details

###### C383MPCL

Multi-pole connection links can be used to connect fuse holders together for multi-pole applications. Use two per connection.

###### C383MPHP

Handle pins can be used to connect handles in multi-pole applications.

#### Technical Data and Specifications

##### Disconnect Fuse Holders ①

Description	Specification
Housing	Polyester UL 94-V0 rated
Color	White
Wire size	8–18 AWG ②
Torque	22 lb-in (2.5 Nm)
Fuse size	0.41 x 1.5 in

#### Dimensions

Approximate Dimensions in Inches (mm)

##### CH163 Series Cover

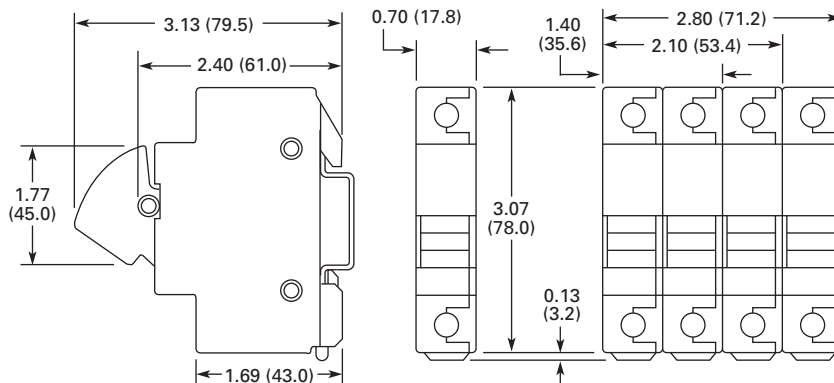

##### Notes

- ① For additional technical information, consult the Eaton web site or Customer Support Center.
- ② UL recognizes both solid and stranded wire. Ferrules are not required. CSA requires ferrules on stranded wire to achieve approval.

### C350 Series Fuse Blocks and W Series Fuse Holders



### Contents

<i>Description</i>	<i>Page</i>
C383 Series Disconnect Fuse Holders . . . . .	<b>V7-T42-129</b>
C350 Series Fuse Blocks and W Series Fuse Holders	
Product Selection . . . . .	<b>V7-T42-132</b>
Accessories . . . . .	<b>V7-T42-133</b>
Technical Data and Specifications . . . . .	<b>V7-T42-133</b>
Dimensions . . . . .	<b>V7-T42-133</b>

### C350 Series Fuse Blocks and W Series Fuse Holders

#### Product Description

##### Fuse Blocks

These space-saving Type C350 Fuse Blocks are UL approved for motor loads and are rated 600V, 30A.

##### Fuse Holders

- Class H, M and R

#### Features

##### Fuse Blocks

- Mount to 35 mm flat and 32 mm asymmetrical DIN rails
- 600V, 30A rated captive pressure plate terminals with copper alloy fuse clips
- Interlocking fuse blocks permit single, double or three-pole application—reduce inventory
- Class CC fuses have an interrupting rating of 200,000A
- Rejection feature prevents insertion of fuses with lower interrupting or voltage ratings

##### Fuse Holders

- Break-resistant: molded of heat-stabilized nylon
- Fuse clips: spring-reinforced for cool operation
- Fuse clip terminations: one-piece construction
- Universal mounting dimensions, for easy assembly and retrofit
- Breathing action collar: maintenance-free
- Pressure wire connectors: vibration resistant

#### Standards and Certifications

Contact Eaton for the latest UL 508A short circuit ratings on terminal blocks.

##### Fuse Blocks

- UL listed
- CSA certified



##### Fuse Holders

- UL tested for OEM subfeed applications



### Fuse Blocks and Adapters

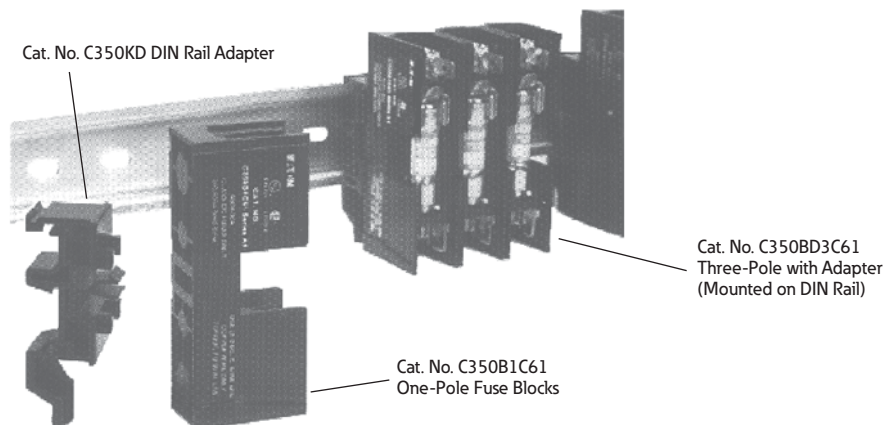

# 42.4

## Terminal Blocks, Fuse Blocks and Fuse Holders

### Fuse Blocks and Fuse Holders

#### Product Selection

#### Class CC Fuse Blocks

Type	Catalog Number
Three-pole ①	C350BD3C61
Single-pole	C350B1C61
DIN adapter	C350KD

42

#### Class R, Three-Pole Fuse Holder



#### Fuse Holders—250V

Wire Termination		Number of Poles	Carton Qty.	30A Catalog Number	Carton Qty.	60A Catalog Number
<b>Class H Fuse Holders</b>						
Single collar (box lug)—sized to ampere rating		1	10	W231HA	10	W261HA
		2	5	W232HA	5	W262HA
		3	5	W233HA	5	W263HA
<b>Class R Fuse Holders</b>						
Single collar (box lug)—sized to ampere rating		1	10	WR231HA	—	—
		2	—	—	—	—
		3	5	WR233HA	1	WR263HA

#### Fuse Holders—600V

Wire Termination		Number of Poles	Carton Qty.	30A Catalog Number	Carton Qty.	60A Catalog Number
<b>Class H Fuse Holders</b>						
Single collar (box lug)—sized to ampere rating		1	10	W631HA	1	W661HA
		2	5	W632HA	1	W662HA
		3	1	W633HA	2	W663HA
<b>Class M Fuse Holders</b>						
Combination of double quick-connect, 20A max., and binding head screw, #10 max., Cu/Al		1	10	WM631F	—	—
		2	8	WM632F	—	—
		3	6	WM633F	—	—
Combination of double quick-connect, 20A max., and pressure plate screw, #10 max., Cu only		1	10	WM631G	—	—
		2	8	WM632G	—	—
		3	6	WM633G	—	—
<b>Class R Fuse Holders</b>						
Single collar (box lug)—sized to ampere rating		1	10	WR631HA	—	—
		2	5	WR632HA	—	—
		3	5	WR633HA	5	WR663HA
Combination of double quick-connect, 20A max., and binding head screw, #10 max., Cu/Al		1	—	—	—	—
		2	1	WMR632F	—	—
		3	6	WMR633F	—	—
Combination of double quick-connect, 20A max., and pressure plate screw, #10 max., Cu only		1	10	WMR631G	—	—
		3	6	WMR633G	—	—
<b>Class R Fuse Holder, Type WRR Control Transformer Fuse Blocks</b>						
Combination of double quick-connect, 20A max., and pressure plate screw, #14–#10 Cu only		3	6	WRR633G	—	—

**Note**

① Three-pole device is supplied with DIN rail adapter.

### Accessories

#### Fuse Holder Accessories

Description	Catalog Number
Fuse puller	TBP
Lighted fuse puller (120 Vac)	TBLP

### Technical Data and Specifications

#### Fuse Blocks

Description	Specification
Voltage rating	600V
Ampere rating	Pressure plate terminals rated for 30A
Dielectric strength	1200V maximum
Ambient temperature	221°F (105°C) maximum
Clip/terminals	Tin-plated copper alloy
Screw and captive pressure plate	Zinc-plated steel
Base	Thermoplastic UL 94V0 flammability rating
DIN rail adapter	Thermoplastic UL 94V0 flammability rating

### Dimensions

Approximate Dimensions in Inches (mm)

#### Fuse Blocks

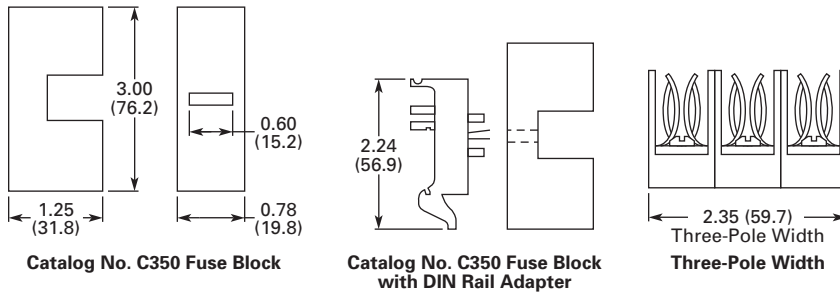

#### Fuse Holders

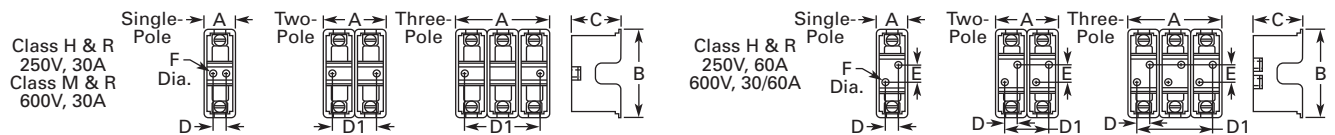

Class	Volts/Amperes	Width A			Height B	Depth C	Mounting Holes			Diameter F	Number of Mounting Holes			
		Single-Pole	Two-Pole	Three-Pole			D	Two-Pole D1	Three-Pole D1		Single-Pole	Two-Pole	Three-Pole	
H, R	250V, 30A	1.00 (25.4)	2.00 (50.8)	3.00 (76.2)	3.13 (79.5)	1.56 (39.6)	0.38 (9.7)	1.25 (31.8)	2.50 (63.5)	—	0.22 (5.6)	2	2	2
	250V, 60A	1.44 (36.6)	2.88 (73.2)	4.31 (109.5)	4.75 (120.7)	2.06 (52.3)	0.50 (12.7)	1.81 (46.0)	3.13 (79.5)	1.25 (31.8)	0.22 (5.6)	2	4	4
	600V, 30/60A	1.69 (42.9)	3.38 (85.9)	5.06 (128.5)	6.94 (176.3)	2.63 (66.8)	0.63 (16.0)	2.19 (55.6)	3.75 (95.3)	3.13 (79.5)	0.28 (7.1)	2	4	4
M, R	600V, 30A	0.84 (21.3)	1.63 (41.4)	2.41 (61.2)	3.00 (76.2)	1.28 (32.5)	0.38 (9.7)	0.75 (19.1)	1.50 (38.1)	—	0.17 (4.3)	2	2	2

# 42.4

## Terminal Blocks, Fuse Blocks and Fuse Holders

### Fuse Blocks and Fuse Holders